

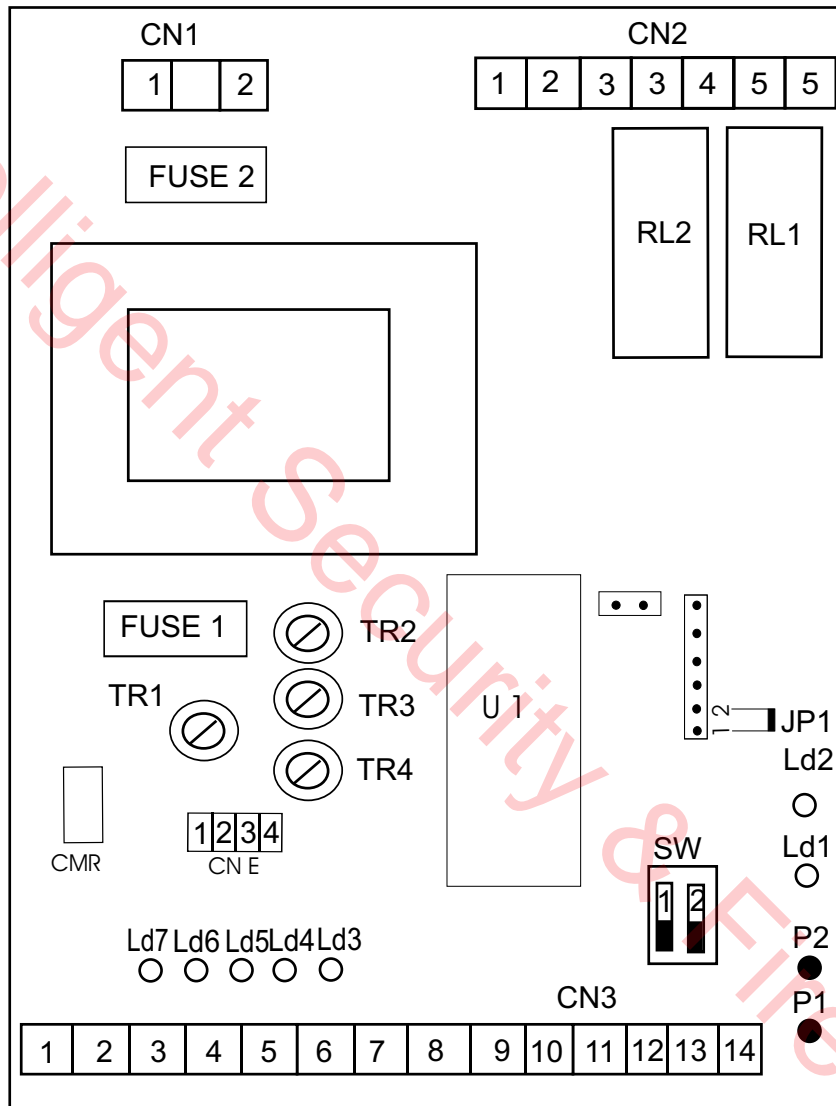

English

# SLIDE NEW MAG CONTROL BOARD

Cod.23001210/15



FUSE 1	Fuse 24V=== (2A)
FUSE 2	Fuse 230V~ (4A) / 110V~ (10A)
TR1	Automatic closing adjustment (0 s - 4 min.)
TR2	Motor torque adjustment
TR3	Ped. Opening time adjustment
TR4	Brake adjustment
SW.1	Logic
SW.2	Closing with photocell
RL 1	Motor direction relay
RL 2	Motor enabling relay
CN 1	Power supply 230/110V~ connector
CN 2	Motor connector - flashing light/courtesy light

CN 3	Accessories connector
CMR	Radio receiver connector
CN E	Encoder connector
LD1	Times/remote controls
LD2	Times/remote controls
LD3	Limit switch 1LED
LD4	Limit switch 2 LED
LD5	Start LED
LD6	Opening safety LED
LD7	Photocell LED
JP1	Encoder activation
U1	Micro-controller
P1	Programming buttons
P2	Programming buttons



## ELECTRIC CONNECTIONS

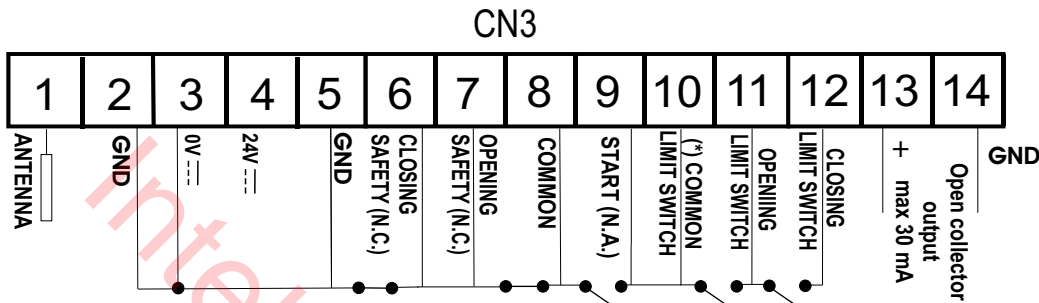

**Note:**  
The open collector pilots a relay commanding a courtesy light.

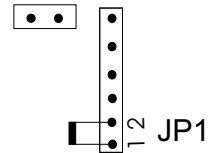
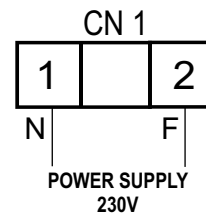
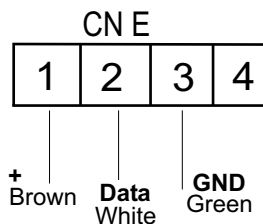
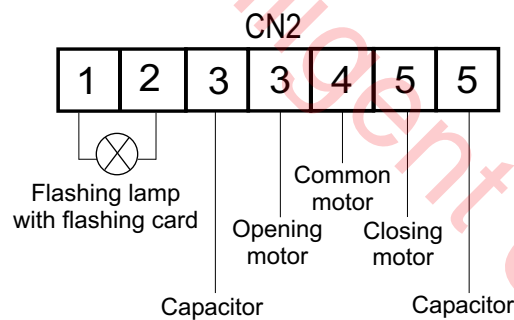

With inserted Jumper the encoder is activated

**Note1:** When not used, bridge the N.C. contacts of safety in opening and/or of the photocell.

**Note2:** Output 24V, max 200mA.

**Note3:** When using the open collector output to manage an electro-lock, it must be powered by the special relay card .

**Security management:** If the security opening command is busy during opening the gate recloses immediately. The command is not active in closing when the safety command (in closing) is busy during closing, the gate reopens. The command is not active in opening.

If the two safeties are both active, the gate will not move and a start command will start it again. The gate will restart in the opposite direction to the last engaged safety.

**Attention:** The motor comes without anti-squeezing security device, it is necessary to use photocells and security edges.



## TRIMMER SETTINGS

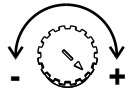
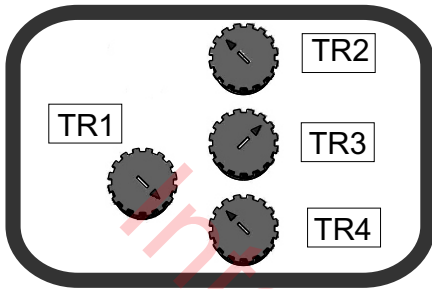

**NOTICE:**  
TURN THE  
TRIMMER  
CLOCKWISE  
TIMES / VALUES  
INCREASE

### **TR1. Trimmer: Automatic reclosing time (0:4 min.)**

It allows to set the pausing time from 0 to 4 min. With trimmer on 0 the logic will be semi-automatic, turning the trimmer clockwise the logic becomes automatic.

### **TR2. Trimmer: Motor torque setting**

Turn the Trimmer completely into clockwise direction for maximum torque.

### **TR3. Trimmer: Pedestrian opening setting**

For pedestrian opening time setting from 0 to 15s.

### **Tr4 Trimmer: Braking on limit switch setting**

For braking force on limit switch setting.

**Note:** It is very important to set the brake in function of the set torque. If the value of the torque decreases, it is necessary to increase the braking value turning the trimmer clockwise.

## DIP SWITCHES SETTING

1	ON	Open-Stop-Close-Open logic	See Step-by-step logic
1	OFF	Automatic/semi-automatic logic (depends on the trimmer setting)	See automatic and semi-automatic logic
2	ON	Reclosure with activated photocell	If the DIP SW 2 is on, the gate will close automatically 2 seconds after having passed the photocell.
2	OFF	Reclosure with disactivated photocell	

## WORKING TIME PROGRAMMING

### Selflearning of the working times with limit switch

- 1) Put the gate on halfway.
- 2) Keep pressed P1 for three seconds, until the LEDs 1 and 2 blink alternately, at this point press P2 and release the two buttons.
- 3) Make sure that the automation starts closing. If the limit switch of closing has been read, the automation does not start automatically in opening again, reverse the limit switches and repeat the selflearning from step 1.
- 4) If the automation starts properly, it will execute automatically a CLOSE-OPEN-CLOSE cycle and will end the learning of the times.



## WORKING LOGICS DESCRIPTION

### **Logic with automatic reclosure from 10 seconds to 4 minutes (Trimmer TR1 turned clockwise):**

A start impulse opens the gate, a start impulse in opening is not accepted, a start impulse during the pausing time closes the gate, a start impulse in closing reopens the gate.

### **Semiautomatic logic (Trimmer TR 1 turned completely counterclockwise):**

A start impulse opens the gate, a start impulse in opening stops the movement, the following impulse opens the gate. A start during pause recloses the gate, a start impulse in closing reopens it.

### **Pedestrian logic (only from radio transmitter)**

A pedestrian start impulse provokes the pedestrian opening. At the end of the pausing time the gate will reclose automatically.

In semiautomatic logic a pedestrian start is necessary to reclose the gate. A pedestrian start during the pedestrian opening reopens the gate. A start during pedestrian pause provokes the total opening.

### **Automatic step-by-step logic can be set from 10 seconds to 4 minutes (TR1 Trimmer turned clockwise)**

The start command follows the OPEN-STOP-CLOSE-OPEN logic.

The automation recloses automatically at the end of the pausing time.

### **Semiautomatic step-by-step logic (TR 1 Trimmer turned completely counterclockwise):**

The start command follows the OPEN-STOP-CLOSE-OPEN logic.

During pause a start impulse is necessary to reclose the gate.

### **Timer function**

It is possible to obtain the timer function keeping busy the start input and setting the automatic reclosure. The gate will close as soon as the contact becomes N.O. again.

### **Encoder Administration**

The encoder allows to obtain the inversion of movement on obstacles. In case of obstacles in both closing and opening the gate will completely reverse. At the next start impulse the gate will start in the opposite direction to the one in which it has revealed the obstacle. If in automatic logic the gate tries to restart for 3 times, at the fourth time it will remain open and the warning lamp will remain switched on. After the fourth consecutive intervention it will be necessary to give a start impulse to restore the movement.

Note: The inversion on obstacle will be controlled till the limit switch has been reached.

### **Attention:**

**In case of no power supply with activated limit switch and Encoder the first movement will be made without inversion control on obstacle, till the limit switch in opening has been reached.**



## RADIO TRANSMITTERS PROGRAMMING

**Note:** The control unit will automatically recognize the linked module (RF Roll Plus or RF standard). With the RF Roll Plus module it is possible to administrate only the COCCINELLA ROLL PLUS and SMART ROLL PLUS remote controls, with the standard RF module it is possible to administrate the COCCINELLA COPY and DIP, the SMART DUAL and the HEAD DIP remote controls.

**Note:** When using remote controls with 12 bits (Coccinella Copy or Smart Dual) it is possible to insert max 48 different codes (1 button = 1 code). It is possible to add further remote controls making copies of one of the already programmed radio transmitters. With Rolling Code remote controls up to 800 different codes can be added but it is not possible to add copies of the radio transmitters.

### Selflearning of the radio transmitter Start

- 1) Press P2 for 3 seconds, LEDs 1 and 2 will flash alternately.
- 2) Press P1 to select LED1, afterwards press P2 (LED1 stays turned on) to confirm the choice and press the button of the radio transmitter to which you want to assign the start. LED 1 switches off, signal has been learned.

### Selflearning of the pedestrian start from radio transmitter

- 1) Press P2 for three seconds, leds 1 and 2 will flash alternately.
- 2) Press P1 twice, to select LED2, afterwards press P2 (LED2 stays turned on) to confirm the choice and press the button of the radio transmitter to which you want to associate the pedestrian start. LED1 switches off, signal has been learned.

### Erasing of all transmitters

- 1) Press P2 for three seconds, the LEDs 1 and 2 will flash alternately.
- 2) Keeping pressed P1, press the P2 button for three times.



**Page for both installer and user**

**WARNINGS**

The electrical installation work should conform to current regulations. A 16A and threshold 0.030A differential switch must be incorporated into the source of the gate main electrical supply and the entire system must be properly earth bonded.

Remember to separate mains (230/115V) carrying cables from low voltage control cables.

**REPLACEMENTS**

To obtain spare parts contact:

**SEA s.r.l. - Zona Ind.le, 64020 S.ATTO - Teramo - Italia**

**PRODUCT USAGE**

The electronic control unit has been planned to be used exclusively as a control device for sliding gates.

**SAFETY AND ENVIRONMENTAL COMPATIBILITY**

We recommend not to spoil the environment with product and circuit packing material.



**Correct Disposal of This Product (Waste Electrical & Electronic Equipment) - Europe only**

(Applicable in the European Union and other European countries with separate collection systems)

This marking shown on the product or its literature, indicates that it should not be disposed with other household wastes at the end of its working life. To prevent possible harm to the environment or human health from uncontrolled waste disposal, please separate this from other types of wastes and recycle it responsibly to promote the sustainable reuse of material resources.

Household users should contact either the retailer where they purchased this product, or their local government office, for details of where and how they can take this item for environmentally safe recycling.

**STORAGE**

<b>STORAGE TEMPERATURES</b>			
<b>T<sub>min</sub></b>	<b>T<sub>Max</sub></b>	<b>Humidity<sub>min</sub></b>	<b>Humidity<sub>Max</sub></b>
- 40°C ↓	+ 85°C ↓	5% <i>not condensation</i>	90% <i>not condensation</i>

When being transported this product must be properly packaged and handled with care.

**MAINTENANCE AND OUT OF SERVICE**

The decommission and maintenance of this product must be carried out by specialised and authorised personnel.

**WARRANTY LIMITS**

For the guarantee see the sales conditions on the official SEA price list.

**NOTE: THE MANUFACTURER CAN NOT BE DEEMED FOR ANY DAMAGE OR INJURY CAUSED BY THE IMPROPER USE OF THIS PRODUCT.**

*SEA reserves the right to do changes or variations that may be necessary to its products and/or this manual with no obligation to notice.*



||| Español |||

# APARATO ELECTRÓNICO SLIDE MAG

Cod.23001210/15

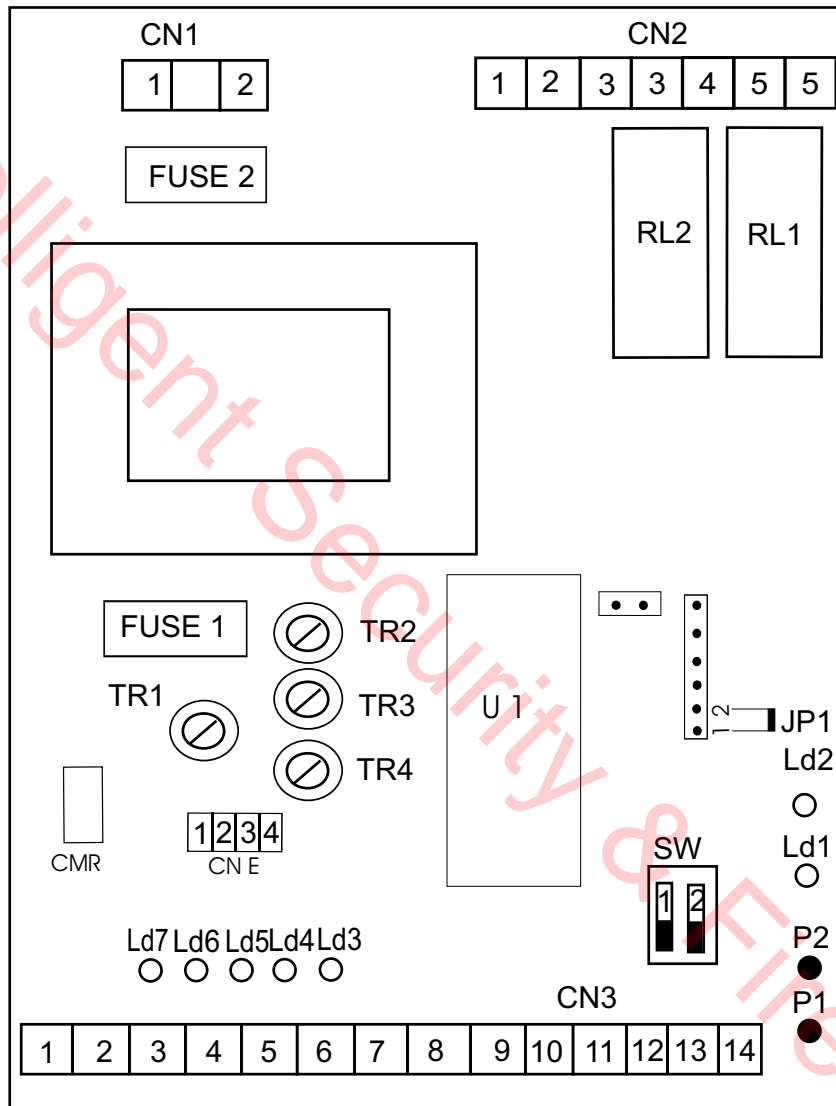

FUSE 1	Fusible 24V--- (2A)
FUSE 2	Fusible 230V ~ (4A) / 110V~ (10A)
TR1	Regulación cierre automático (0 s - 4 min.)
TR2	Regulación cupla motor
TR3	Regul. Tiempo de ap. Peat.
TR4	Regulación frenada
SW.1	Lógica
SW.2	Cierre con fotocélula
RL 1	Relé dirección motor
RL 2	Relé activación motor
CN 1	Conector alimentación 230/110V~
CN 2	Conector motor - lampara/luz de cortesía

CN 3	Conector accesorios
CMR	Conector receptor de radio
CN E	Conector Encoder
LD1	Progr.tiempo/radiocomandos
LD2	Progr.tiempo/radiocomandos
LD3	Led de final de carrera 1
LD4	Led de final de carrera 2
LD5	Led de start
LD6	Led seguridad apertura
LD7	Led fotocélula
JP1	Activación Encoder
U1	Microcontrollore
P1	Botones de programación
P2	Botones de programación





## CONEXIONES ELECTRICAS

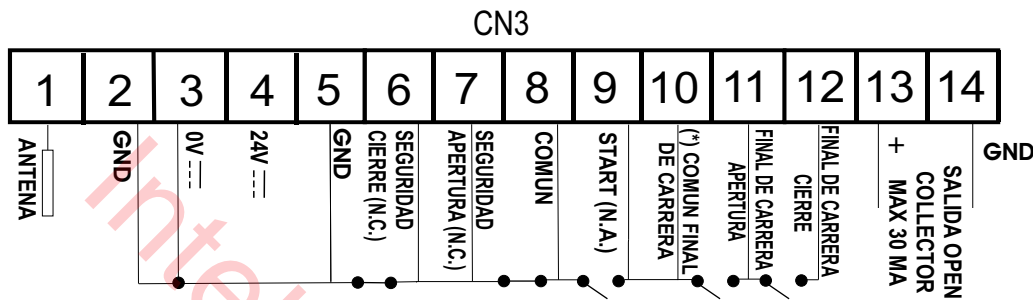

Nota:  
La salida "open collector" pilotará un relay que podrá mandar una luz de cortesia.

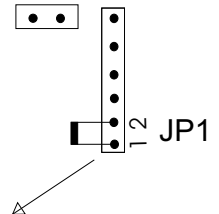
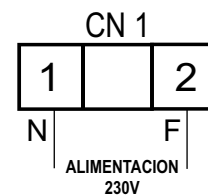
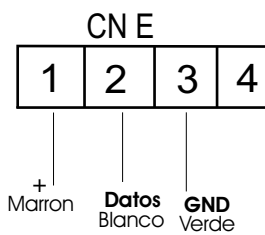
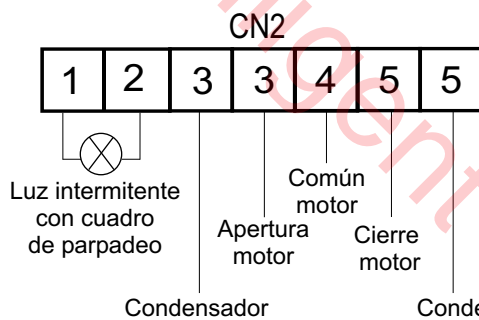

Con Jumper insertado se activa el Encoder

**Nota 1:** Si no son utilizados, puentear lo contactos normalmente cerrados de la Seguridad en apertura y/o de la fotocélula.

**Nota2:** salida 24V, max 200mA

**Gestión seguridad:** el mando Seguridad apertura si empeñado durante el apertura provoca el cierre inmediato. El mando no está activo en cierre.

El mando Seguridad cierre si empeñado durante el cierre provoca la reapertura de la cancela. El mando no está activo en apertura.

Si las dos seguridades resultan ambas activas, la cancela quedará parada y será necesario un mando de start para hacer repartir la cancela.

La cancela repartirá en el verso opuesto a la última seguridad empeñada.

**Atención:** el motor está desprovisto de seguridades anti-aplastamiento, es necesario el utilizo de fotocélulas y costas de seguridad.





## REGULACION TRIMMER Y DIP SWITCHES

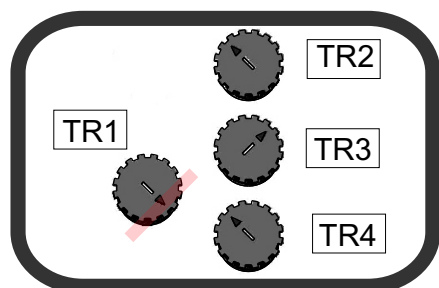

### **TR1. Trimmer Tiempo de cierre automático (0:4 min.)**

Este Trimmer permite la regulación del tiempo de pausa en un intervalo que puede asumir todos los valores incluidos entre 0 s y 4 min. Con trimmer a 0 la lógica resulta semiautomática, girando el trimmer en sentido horario, la lógica se pondrá automática.

### **TR2. Trimmer regulación de la cupla**

Este trimmer permite regular la cupla del motor, Trimmer todo en sentido retrógrado, cupla máxima.

### **TR3. Trimmer de regulación abertura peatonal**

Regulará el tiempo de abertura peatonal entre 0 y 15 s.

### **TR4. Trimmer por la regulación de la frenada sobre el fin de carrera**

Regla la fuerza de frenada sobre el fin de carrera.

**Nota: es muy importante que se ajuste la frenada en función de la regulación de la cupla. Si se reduce el valor de la cupla es necesario subir la frenada girando el trimmer TR4 en sentido horario.**

## POSICIÓN DIP SWITCHES

1	ON	Lógica abre-stop-cierra-abre	Ver lógica Paso Paso
1	OFF	Lógica automática/semiautomática (según la fijación del trimmer)	Ver lógica Automática e Semiautomática
2	ON	Richiusura con fotocellula abilitata	Si el dip sw está en ON al cruzar la fotocelda después dos segundos habrá el cierre automático.
2	OFF	Richiusura con fotocellula disabilitata	

## PROGRAMACIÓN TIEMPOS DE TRABAJO

### **Autoaprendizaje de los tiempos de trabajo con final de carrera**

- 1) Poner la automatización a medias corrida.
- 2) Tener comprimido P1 por tres segundos, hasta que los led 1 y 2 no relampagueará alternativamente, a este punto comprimir P2 y conceder los dos interruptores.
- 3) Observar que la automatización parta en cierre. Si leyera el final de carrera de cierre la automatización no reparte automáticamente en abertura, invertir los finales de carrera y repetir el autoaprendizaje del punto 1.
- 4) Si la automatización reparte correctamente ira ejecutando un ciclo CIERRA-ABRE-CIERRA y acabará el aprendizaje de los tiempos.



## DESCRIPCION LOGICA DE FUNCIONAMIENTO

### **Lógica con cierre automático arreglable de 10 segundos hasta 4 minutos (Trimmer TR1 rodeado en sentido horario)**

Un impulso de start abre la cancela, un start en apertura no viene aceptado, un start en pausa cierra, un start en cierre vuelve abrir.

### **Lógica semiautomática (SW1 en OFF) (Trimmer TR1 todo en sentido anti-horario):**

Un impulso de start abre la cancela, un start en apertura para el movimiento, el siguiente abre. Un start en pausa cierra la cancela un start en cierre vuelve abrir.

### **Lógica Peatonal (sólo de radiocomando):**

Un impulso de start peatonal provoca la abertura peatonal, acabado el tiempo de pausa se obtiene el cierre automático del peatonal.

En lógica semiautomática será necesario un start peatonal para cerrar la automatización. Un impulso de start peatonal durante la abertura peatonal reabre el peatonal. Un impulso de start durante la pausa peatonal, provoca la abertura total.

### **Lógica paso paso automática arreglable de 10 segundos hasta 4 minutos (Trimmer TR1 rodeado en sentido horario)**

El mando de start sigue la lógica ABRE-STOP-CIERRA-ABRE.

Al acabarse el tiempo de pausa el automatismo va a cerrar automáticamente.

### **Lógica paso paso semiautomática (Trimmer TR1 todo en sentido anti-horario):**

El mando de start sigue la lógica ABRE-STOP-CIERRA-ABRE.

En pausa será necesario un impulso de start para cerrar el automatismo.

### **Función temporizador**

Es posible conseguir la función temporizador al tener empeñado la entrada de start y programando el cierre automático. La cancela cerrará en cuanto el contacto vuelve N.O.

### **Gestión Encoder**

El Encoder permite de conseguir la inversión del movimiento sobre obstáculo. En caso de obstáculo sea en cierre que abertura hay la inversión total del movimiento. Al start siguiente la automatización saldrá en la dirección opuesta a aquel en que ha notado el obstáculo. Si en lógica automática la cancela intenta partir para 3 veces a la cuarta vez quedará abierta y la lámpara quedará encendida. Después la cuarta intervención consecutiva será necesario un start para conseguir el restablecimiento del movimiento.

Nota: El control de la inversión sobre obstaculizo habrá hasta el logro del final de carrera.

### **Atención:**

**En caso de falla de alimentación con fines de carrera y Encoder activos la primera maniobra ocurrirá sin control de inversión sobre obstáculo hasta el logro del final de carrera de abertura.**



## PROGRAMACIÓN RADIOCOMANDOS

**Nota:** La central reconocerá automáticamente si es conectado un módulo RF Roll Plus o un módulo RF estándar. Con módulo RF Roll Plus será posible sólo administrar los radiocomandos Coccinella Roll Plus y Smart Roll Plus, con módulo RF estándar será posible administrar los radiocomandos Coccinella Copy y Dip, los Smart Dual y los Head dip.

**Nota:** Si se emplean transmisores a 12 bit (Coccinella Copy o Smart Dual) es posible introducir un máximo de 48 códigos diferentes ( 1 pulsador = 1 código). Es posible también añadir ulteriores transmisores realizando las copias de uno de los transmisores ya programados.

Si se emplean los transmisores Rolling Code es posible introducir hasta 800 códigos diferentes, pero no se pueden añadir copias de transmisores.

### Autoapprendissaje del start de un transmisor

- 1) Oprimir el pulsante P2 por tres segundos, los led 1 y 2 relampaguearan alternativamente.
- 2) Pisar P1 para seleccionar el led1, luego comprimir P2 (el led1 quedará encendido fijo), para confirmar la elección y pisar el interruptor del radiocomando a que se quiere asociar el start. El led1 se apaga, señal adquirida.

### Autoapprendissaje del start peatonal de radiocomando

- 1) Oprimir P2 por tres segundos, los led 1 y 2 relampaguearan alternativamente.
- 2) Oprimir P1 por 2 veces, para seleccionar el led2, luego comprimir P2 (el led2 quedará encendido fijo) para confirmar la elección y pisar el interruptor del radiocomando a que se quiere asociar el start peatonal. El led1 se apaga, señal adquirida.

### Cancelacion de todos los transmisores

- 1) Oprimir el pulsante P2 por tres segundos, los led 1 e 2 relampagueran alternativamente.
- 2) Teniendo oprimido P1, oprimir tres veces el pulsante P2.



## Sección para el usuario final y el instalador

### ADVERTENCIA

La instalación eléctrica y la lógica de funcionamiento deben estar de acuerdo con la normativa vigente. Prever en cada caso un interruptor diferencial puesto al inicio de la instalación eléctrica de la automatización de 16A y umbral de intervención de 0,030A. Tener separados los cables de potencia (motor, alimentaciones etc.) de los de mando (pulsadores, fotocélulas, receptores radio etc.). Para evitar interferencias es preferible prever y utilizar al menos dos vainas separadas.

### REPUESTOS

Los pedidos de repuestos tienen que ser enviados a:

**SEA s.r.l. - Zona Ind.le, 64020 S.ATTO - Teramo - Italia**

### UTILIZACION

La maniobra electrónica 23001210/15 ha sido proyectada para ser utilizada exclusivamente como tarjeta de mando para la automatización de cancelas corredizas.

### SEGURIDAD Y COMPATIBILIDAD DEL AMBIENTE

Es importante no dispersar en el ambiente los materiales de embalaje del producto y/o los circuitos.



**Eliminación correcta de este producto (material electrónico de descarte) - Europa solamente**

(Aplicable en la Unión Europea y en países europeos con sistemas de recogida selectiva de residuos)

La presencia de esta marca en el producto o en el material informativo que lo acompaña, indica que al finalizar su vida útil no deberá eliminarse junto con otros residuos domésticos. Para evitar los posibles daños al medio ambiente o a la salud humana que representa la eliminación incontrolada de residuos, separe este producto de otros tipos de residuos y recíclelo correctamente para promover la reutilización sostenible de recursos materiales. Los usuarios particulares pueden contactar con el establecimiento donde adquirieron el producto, o con las autoridades locales pertinentes, para informarse sobre cómo y dónde pueden llevarlo para que sea sometido a un reciclaje ecológico y seguro. Los usuarios comerciales pueden contactar con su proveedor y consultar las condiciones del contrato de compra. Este producto no debe eliminarse mezclado con otros residuos comerciales.

### ALMACENAMIENTO

#### TEMPERATURAS DE ALMACENAMIENTO

$T_{min}$	$T_{Max}$	Humedad <sub>min</sub>	Humedad <sub>Max</sub>
- 40°C	+ 85°C	5% no condensable	90% no condensable

El manejo del producto tiene que ser efectuado con medios idóneos.

### PUESTA FUERA DE SERVICIO Y MANUTENCION

La desinstalación y/o puesta fuera de servicio y/o manutención de la maniobra electrónica 23001210/15 tiene que ser efectuada solo y exclusivamente por personal autorizado y experto.

### LIMITE DE GARANTIA

Por la garantía se vean las Condiciones de venta indicadas en el catálogo oficial SEA.

**N.B. EL FABRICANTE NO PUEDE SER CONSIDERADO RESPONSABLE POR EVENTUALES DAÑOS ACARREADOS POR USO IMPROPIO, ERRONEO E IRRAZONABLE.**

*La SEA se reserva el derecho de aportar modificaciones o variaciones que fueran oportunas a sus productos y/o al presente manual sin obligación alguna de aviso previo.*



## TERMS OF SALES

**EFFICACY OF THE FOLLOWING TERMS OF SALE:** the following general terms of sale shall be applied to all orders sent to SEA srl. All sales made by SEA to all costumers are made under the prescription of this terms of sales which are integral part of sale contract and cancel and substitute all apposed clauses or specific negotiations present in order document received from the buyer.

**GENERAL NOTICE** The systems must be assembled exclusively with SEA components, unless specific agreements apply. Non-compliance with the applicable safety standards (European Standards EM12453 – EM 12445) and with good installation practice releases SEA from any responsibilities. SEA shall not be held responsible for any failure to execute a correct and safe installation under the above mentioned standards.

**1) PROPOSED ORDER** The proposed order shall be accepted only prior SEA approval of it. By signing the proposed order, the Buyer shall be bound to enter a purchase agreement, according to the specifications stated in the proposed order.

On the other hand, failure to notify the Buyer of said approval must not be construed as automatic acceptance on the part of SEA.

**2) PERIOD OF THE OFFER** The offer proposed by SEA or by its branch sales department shall be valid for 30 solar days, unless otherwise notified.

**3) PRICING** The prices in the proposed order are quoted from the Price List which is valid on the date the order was issued. The discounts granted by the branch sales department of SEA shall apply only prior to acceptance on the part of SEA. The prices are for merchandise delivered ex-works from the SEA establishment in Teramo, not including VAT and special packaging. SEA reserves the right to change at any time this price list, providing timely notice to the sales network. The special sales conditions with extra discount on quantity basis (Qx, Qx1, Qx2, Qx3 formula) is reserved to official distributors under SEA management written agreement.

**4) PAYMENTS** The accepted forms of payment are each time notified or approved by SEA. The interest rate on delay in payment shall be 1.5% every month but anyway shall not be higher than the max. interest rate legally permitted.

**5) DELIVERY** Delivery shall take place, approximately and not peremptorily, within 30 working days from the date of receipt of the order, unless otherwise notified. Transport of the goods sold shall be at Buyer's cost and risk. SEA shall not bear the costs of delivery giving the goods to the carrier, as chosen either by SEA or by the Buyer. Any loss and/or damage of the goods during transport, are at Buyer's cost.

**6) COMPLAINTS** Any complaints and/or claims shall be sent to SEA within 8 solar days from receipt of the goods, proved by adequate supporting documents as to their truthfulness.

**7) SUPPLY** The concerning order will be accepted by SEA without any engagement and subordinately to the possibility to get it's supplies of raw material which is necessary for the production; Eventual completely or partially unsuccessful executions cannot be reason for complains or reservations for damage. SEA supply is strictly limited to the goods of its manufacturing, not including assembly, installation and testing. SEA, therefore, disclaims any responsibility for damage deriving, also to third parties, from non-compliance of safety standards and good practice during installation and use of the purchased products.

**8) WARRANTY** The standard warranty period is 12 months. This warranty time can be extended by means of expedition of the warranty coupon as follows:

**SILVER:** The mechanical components of the operators belonging to this line are guaranteed for 24 months from the date of manufacturing written on the operator.

**GOLD:** The mechanical components of the operators belonging to this line are guaranteed for 36 months from the date of manufacturing written on the operator.

**PLATINUM:** The mechanical components of the operators belonging to this line are guaranteed for 36 months from the date of manufacturing written on the operator. The base warranty (36 months) will be extended for further 24 months (up to a total of 60 months) when it is acquired the certificate of warranty which will be filled in and sent to SEA s.r.l. The electronic devices and the systems of command are guaranteed for 24 months from the date of manufacturing. In case of defective product, SEA undertakes to replace free of charge or to repair the goods provided that they are returned to SEA repair centre. The definition of warranty status is by unquestionable assessment of SEA. The replaced parts shall remain propriety of SEA. Binding upon the parties, the material held in warranty by the Buyer, must be sent back to SEA repair centre with fees prepaid, and shall be dispatched by SEA with carriage forward. The warranty shall not cover any required labour activities.

The recognized defects, whatever their nature, shall not produce any responsibility and/or damage claim on the part of the Buyer against SEA. The guarantee is in no case recognized if changes are made to the goods, or in the case of improper use, or in the case of tampering or improper assembly. Furthermore, the warranty shall not apply if SEA products are partly or completely coupled with non-original mechanical and/or electronic components, and in particular, without a specific relevant authorization, and if the Buyer is not making regular payments. The warranty shall not cover damage caused by transport, expendable material, faults due to non-conformity with performance specifications of the products shown in the price list. No indemnification is granted during repairing and/or replacing of the goods in warranty. SEA disclaims any responsibility for damage to objects and persons deriving from non-compliance with safety standards, installation instructions or use of sold goods.

**9) RESERVED DOMAIN** A clause of reserved domain applies to the sold goods; SEA shall decide autonomously whether to make use of it or not, whereby the Buyer purchases propriety of the goods only after full payment of the latter.

**10) COMPETENT COURT OF LAW** In case of disputes arising from the application of the agreement, the competent court of law is the tribunal of Teramo. SEA reserves the faculty to make technical changes to improve its own products, which are not in this price list at any moment and without notice. SEA declines any responsibility due to possible mistakes contained inside the present price list caused by printing and/or copying. The present price list cancels and substitutes the previous ones. The Buyer, according to the law No. 196/2003 (privacy code) consents to put his personal data, deriving from the present contract, in SEA archives and electronic files, and he also gives his consent to their treatment for commercial and administrative purposes. Industrial ownership rights: once the Buyer has recognized that SEA has the exclusive legal ownership of the registered SEA brand, he will commit himself to use it in a way which does not reduce the value of these rights, he won't also remove, replace or modify brands or any other particularity from the products. Any kind of replication or use of SEA brand is forbidden as well as of any particularity on the products, unless preventive and expressed authorization by SEA.

**In accomplishment with art. 1341 of the Italian Civil Law it will be approved expressly clauses under numbers:**

**4) PAYMENTS - 8) GUARANTEE - 10) COMPETENT COURT OF LAW**





**English GENERAL NOTICE FOR THE INSTALLER AND THE USER**

1. Read carefully these **Instructions** before beginning to install the product. Store these instructions for future reference
2. Don't waste product packaging materials and /or circuits.
3. This product was designed and built strictly for the use indicated in this documentation. Any other use, not expressly indicated here, could compromise the good condition/operation of the product and/or be a source of danger. SEA srl declines all liability caused by improper use or different use in respect to the intended one.
4. The mechanical parts must be comply with Directives: Machine Regulation 2006/42/CE and following adjustments), Low Tension (2006/95/CE), electromagnetic Consistency (2004/108/CE) Installation must be done respecting Directives: EN12453 and En12445.
5. Do not install the equipment in an explosive atmosphere.
6. SEA srl is not responsible for failure to observe Good Techniques in the construction of the locking elements to motorize, or for any deformation that may occur during use.
7. Before attempting any job on the system, cut out electrical power and disconnect the batteries. Be sure that the earthing system is perfectly constructed, and connect it metal parts of the lock.
8. Use of the indicator-light is recommended for every system, as well as a warning sign well-fixed to the frame structure.
9. SEA srl declines all liability as concerns the automated system's security and efficiency, if components used, are not produced by SEA srl.
10. For maintenance, strictly use original parts by SEA.
11. Do not modify in any way the components of the automated system.
12. The installer shall supply all information concerning system's manual functioning in case of emergency, and shall hand over to the user the warnings handbook supplied with the product.
13. Do not allow children or adults to stay near the product while it is operating. The application cannot be used by children, by people with reduced physical, mental or sensorial capacity, or by people without experience or necessary training. Keep remote controls or other pulse generators away from children, to prevent involuntary activation of the system.
14. Transit through the leaves is allowed only when the gate is fully open.
15. The User must not attempt to repair or to take direct action on the system and must solely contact qualified SEA personnel or SEA service centers. User can apply only the manual function of emergency.
16. The power cables maximum length between the central engine and motors should not be greater than 10 m. Use cables with 2,5 mm<sup>2</sup> section. Use double insulation cable (cable sheath) to the immediate vicinity of the terminals, in particular for the 230V cable. Keep an adequate distance (at least 2.5 mm in air), between the conductors in low voltage (230V) and the conductors in low voltage safety (SELV) or use an appropriate sheath that provides extra insulation having a thickness of 1 mm.

**Español ADVERTENCIAS GENERALES PARA INSTALADORES Y USUARIOS**

- 1 Leer las **instrucciones de instalación** antes de comenzar la instalación. Mantenga las instrucciones para consultas futura
2. No desperdiciar en el ambiente los materiales de embalaje del producto o del circuito
3. Este producto fue diseñado y construido exclusivamente para el uso especificado en esta documentación. Cualquier otro uso no expresamente indicado puede afectar la integridad del producto y ser una fuente de peligro. El uso inadecuado es también causa de anulación de la garantía. SEA srl se exime de toda responsabilidad causadas por uso inapropiado o diferente de aquel para el que el sistema automatizado fue producido.
4. Los productos cumplen con la Directiva: Maquinas (2006/42/CE y siguientes modificaciones), Baja Tension (2006/95/CE, y siguientes modificaciones), Compatibilidad Electromagnética (2004/108/CE modificada). La instalación debe ser llevada a cabo de conformidad a las normas EN 12453 y EN 12445.
5. No instalar el dispositivo en una atmósfera explosiva.
6. SEA srl no es responsable del incumplimiento de la mano de obra en la construcción de la cancela a automatizar y tampoco de las deformaciones que puedan producirse durante el uso.
7. Antes de realizar cualquier operación apagar la fuente de alimentación y desconectar las baterías. Comprobar que el sistema de puesta a tierra sea diseñado de una manera profesional y conectar las partes metálicas del cierre.
8. Para cada instalación se recomienda utilizar como mínimo una luz parpadeante y una señal de alarma conectada a la estructura del marco.
9. SEA srl no acepta responsabilidad por la seguridad y el buen funcionamiento de la automatización en caso de utilización de componentes no producidos por SEA.
10. Para el mantenimiento utilizar únicamente piezas originales SEA srl.
11. No modificar los componentes del sistema automatizado.
12. El instalador debe proporcionar toda la información relativa al funcionamiento manual del sistema en caso de emergencia y darle al usuario el folleto de adjunto al producto.
13. No permita que niños o adultos permanecen cerca del producto durante la la operación. La aplicación no puede ser utilizada por niños, personas con movilidad reducida de tipo físico, mental, sensorial o igual por personas sin experiencia o formación necesaria. Tener los radiomandos fuera del alcance de niños así como cualquier otro generador de impulsos radio para evitar que el automación pueda ser accionada accidentalmente.
14. El tránsito a través de las hojas sólo se permite cuando la puerta está completamente abierta.
15. Todo el mantenimiento, reparación o controles deberán ser realizados por personal cualificado. Evitar cualquier intento a reparar o ajustar. En caso de necesidad comunicarse con un personal SEA calificado. Sólo se puede realizar la operación manual.
16. La longitud máxima de los cables de alimentación entre motor y central no debe ser superior a 10 metros. Utilizar cables con 2,5 mm<sup>2</sup>. Utilizar cables con doble aislamiento (cables con vaina) hasta muy cerca de los bornes, especialmente por el cable de alimentación (230V). Además es necesario mantener adecuadamente distanciados (por lo menos 2,5 mm en aire) los conductores de baja tensión (230V) y los conductores de baja tensión de seguridad (SELV) o utilizar una vaina adecuada que proporcione aislamiento adicional con un espesor mínimo de 1 mm.



**SEA**®

electronic opening system

Questo articolo è stato prodotto seguendo rigide procedure di lavorazione ed è stato testato singolarmente al fine di garantire i più alti livelli qualitativi e la vostra soddisfazione. Vi ringraziamo per aver scelto SEA.

This item has been produced following strict production procedures and has been singularly tested for the highest quality levels and for your complete satisfaction. Thanks for choosing SEA.

Cet article a été produit suivant des procédures d'usinage strictes et il a singulièrement été testé afin de garantir les plus hauts niveaux de qualité pour votre satisfaction. Nous vous remercions d'avoir choisi SEA.

Este artículo ha sido producido siguiendo rigidos procedimientos de elaboracion y ha sido probando singolarmente a fin de garantizar los mas altos niveles de calidad y vuestra satisfaccion. Le agradecemos por haber escogito SEA.



Intelligent Security & Fire Ltd.

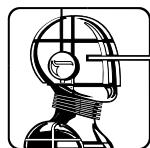

**SEA**<sup>®</sup>

Sistemi Elettronici  
di Apertura Porte e Cancelli  
International registered trademark n. 804888



**SEA S.r.l.**  
**Zona industriale 64020 S.ATTO Teramo (ITALY)**  
**Tel. 0861 588341 r.a. Fax 0861 588344**

**seacom@seateam.com**

**www.seateam.com**