



### NET230N 230V a.c. operators without control board and rod cover

COD.	Art.				OTHER CHARACTERISTICS
627000	<b>351/SC</b>	●	320mm		For leaves up to 3 mt. long
627012	<b>351EN/SC</b>	●	320mm	●	With encoder, for leaves up to 3 mt. long
627021	<b>352/SC</b>	●	320mm		With limit switches, for leaves up to 3 mt. long
627031	<b>353/SC</b>	●	320mm		<b>Not self-locking</b> , for leaves up to 3 mt. long
627041	<b>354/SC</b>	●	320mm		With limit switches, <b>not self-locking</b> for leaves up to 3 mt. long
627053	<b>355/SC</b>	●	520mm		For leaves up to 4,5 mt. long
627052	<b>355EN/SC</b>	●	520mm	●	With encoder, for leaves up to 4,5 mt. long
627061	<b>356/SC</b>	●	520mm		With limit switches, for leaves up to 4,5 mt. long
627071	<b>357/SC</b>	●	520mm		<b>Not self-locking</b> , for leaves up to 4,5 mt. long
627081	<b>358/SC</b>	●	520mm		With limit switches, <b>not self-locking</b> for leaves up to 4,5 mt. long

**All models have:** fixing plates to be screwed included, rod cover not included

**Control board to complete the installation:** control board cod. 677610 art. NET230N/C (with box)

### NET24N 24V d.c. operators without control board and rod cover

COD.	Art.				OTHER CHARACTERISTICS
627092	<b>371E/SC</b>	●	320mm		For leaves up to 1,8 mt. long
627090	<b>371/SC</b>	●●	320mm		For leaves up to 3 mt. long
627102	<b>371EN/SC</b>	●●	320mm	●	With encoder, for leaves up to 3 mt. long
627111	<b>372/SC</b>	●●	320mm		With limit switches, for leaves up to 3 mt. long
627123	<b>373/SC</b>	●●	520mm		For leaves up to 4,5 mt. long
627124	<b>373EN/SC</b>	●●	520mm	●	With encoder, for leaves up to 4,5 mt. long
627131	<b>374/SC</b>	●●	520mm		With limit switches, for leaves up to 4,5 mt. long

**All models have:** fixing plates to be screwed included, rod cover not included

**Control board to complete the installation:** control board cod. 678261 art. NET24N/C (with box)

**Limit switches set up:** articles 352, 354, 356, 358, 372 and 374 are supplied with built-in limit switches in open and closed position, to be connected to the control board.

### Rod cover



COD.	Art.		OTHER CHARACTERISTICS
629340	<b>CS320</b>	320mm	Rod cover stroke 320 mm.
629341	<b>CS520</b>	520mm	Rod cover stroke 520 mm.

TECHNICAL INFO	351 352 351EN	353 354	355 356 355EN	357 358	371E	371 371EN 372	373 374 373EN
Motor power supply (V)		230 AC ± 10 % (50/60 Hz)			24 DC	24 DC	24 DC
Maximum power absorption (W)	300	300	300	300	50	60	60
Max thrust (N)	1650	1200	1650	1200	500	1000	1000
Duty cycle (cycles/hours)	22 - 25 (vers. 351EN)	22	22 - 25 (vers. 355EN)	22	10	40	40
N. max cycles in 24h.	110	110	110	110	50	110	110
Built-in capacitor (µF)	8	10	8	10	/	/	/
Operating temperature (°C)	-20 ÷ 50	-20 ÷ 50	-20 ÷ 50	-20 ÷ 50	-20 ÷ 50	-20 ÷ 50	-20 ÷ 50
Motor thermal protection (°C)	150	150	150	150	/	/	/
90° Opening time (s)	16	12,5	17	13,5	15	14	15
Weight with packing (Kg)	9	9	9,5	9,5	9	9	9
Protection degree	IP24	IP24	IP24	IP24	IP24	IP24	IP24

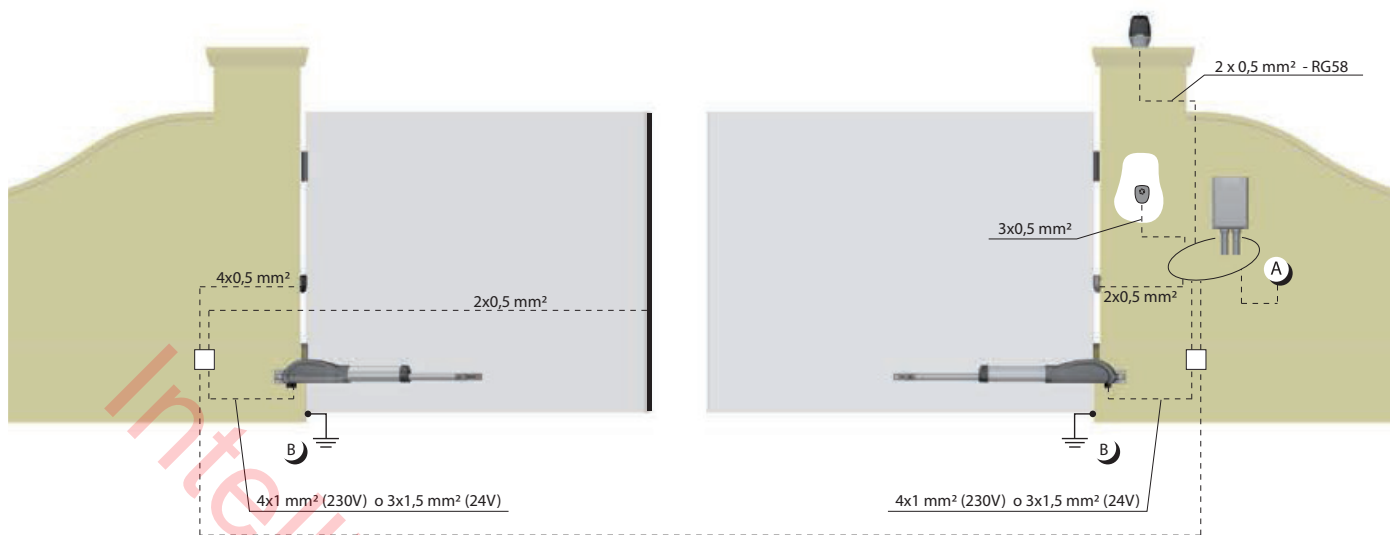

EXAMPLE OF A TYPICAL INSTALLATION

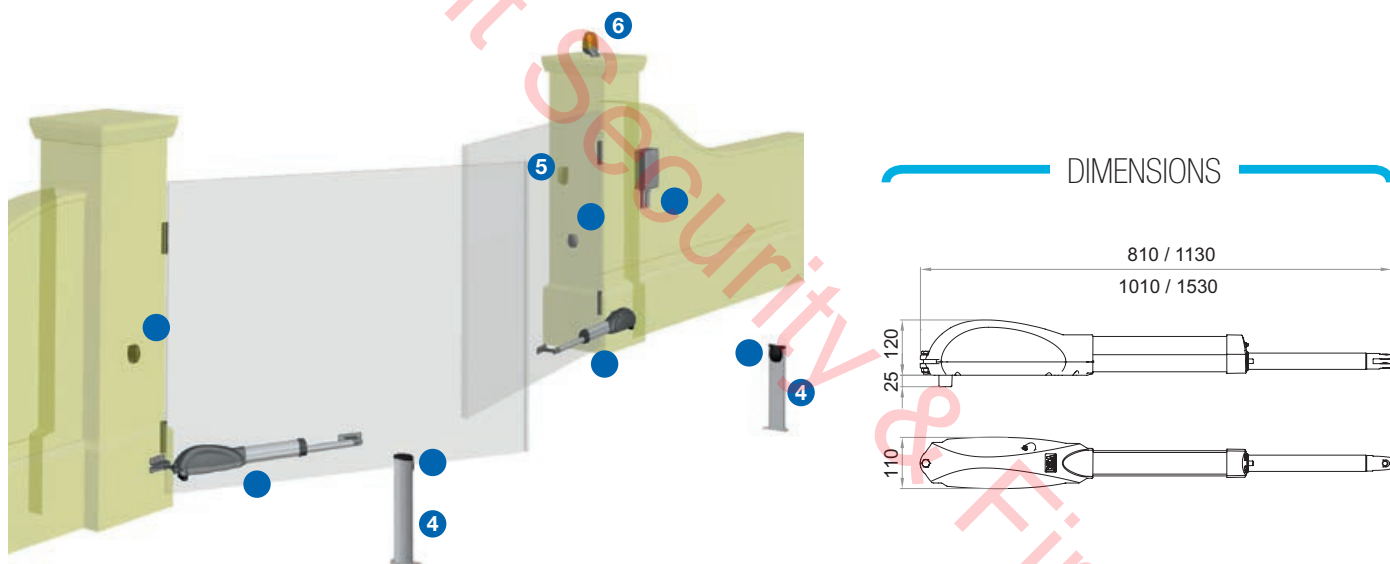

**●** Cod. 627012  
**Art. 351EN/SC**  
Electromechanical operator for swing gates

**●** Cod. 677610  
**Art. NET230N/C**  
Universal digital control board for 1 or 2 operators, 230V, with or without magnetic encoder (with box)

**●** Cod. 662030  
**Art. 104LUX**  
Pair of adjustable (15°) surface mounted photocells

**4** Cod. 664000  
**Art. PILLY/60**  
Pair of aluminium columns for photocells, height 55 cm.

**5** Cod. 663030  
**Art. 102LUX**  
Keyswitch with two contacts, flush mounted. Supplied with 2 keys.

**6** Cod. 661062  
**Art. LED230AI**  
Led flashing light 230V with built-in antenna 433Mhz

Cod. 672580  
**Art. TR2**  
Remote control  
Black version art. TR2N also available (page 118)

Cod. 668010  
**Art. 127**  
Warning sign

## SPECIFIC ACCESSORIES



Cod. 629320  
**Art. MAC-LOOK/P**  
Extension for MAC and LOOK rams



Cod. 629311  
**Art. LOOK/SFR**  
Adjustable brackets for LOOK

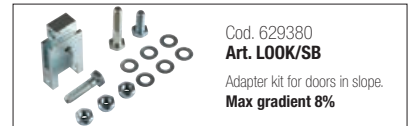

Cod. 629380  
**Art. LOOK/SB**  
Adapter kit for doors in slope.  
**Max gradient 8%**



Cod. 629250  
**Art. COL 515**  
Anti-falling stainless steel cable with 2 holes for swing doors

## OTHER ACCESSORIES

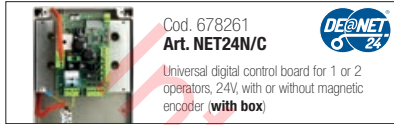

Cod. 678261  
**Art. NET24N/C**  
Universal digital control board for 1 or 2 operators, 24V, with or without magnetic encoder (with box)

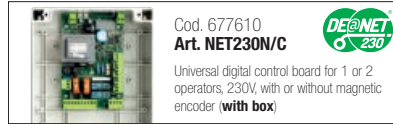

Cod. 677610  
**Art. NET230N/C**  
Universal digital control board for 1 or 2 operators, 230V, with or without magnetic encoder (with box)

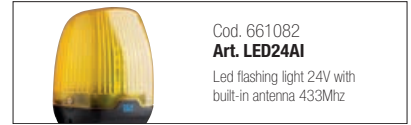

Cod. 661082  
**Art. LED24AI**  
Led flashing light 24V with built-in antenna 433Mhz



Cod. 661062  
**Art. LED230AI**  
Led flashing light 230V with built-in antenna 433Mhz

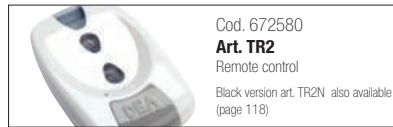

Cod. 672580  
**Art. TR2**  
Remote control  
Black version art. TR2N also available (page 118)

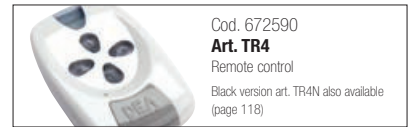

Cod. 672590  
**Art. TR4**  
Remote control  
Black version art. TR4N also available (page 118)



Cod. 662020  
**Art. 104MINILUX**  
Pair of surface mounted photocells, Range 20 mt



Cod. 662030  
**Art. 104LUX**  
Pair of adjustable (15°) surface mounted photocells



Cod. 662044  
**Art. LINEAR**  
Pair of adjustable photocells (180°) with possibility of synchronized operating. Range 20 Mt



Cod. 662043  
**Art. LINEAR/B**  
Pair of adjustable photocells (180°) with tx supplied by a LiON battery. Range 7/15 Mt



Cod. 681060  
**Art. COVER**  
Vandal-proof aluminium cover for art. LINEAR and LINEAR/B



Cod. 663060  
**Art. KYO**  
Aluminium vandal-proof keyswitch, flush mounted.



Cod. 663280  
**Art. DIGIRAD**  
Wireless keypad



Cod. 663270  
**Art. DIGINET**  
Hardwired keypad for BUS connections to MASTER devices of range DE@NET (NET24N, NET230N, MASTERNET)



Cod. 664020  
**Art. PILLY/base**  
Pair of fixing plates for columns to be cemented.



Cod. 664000  
**Art. PILLY/60**  
Pair of aluminium columns for photocells, height 55 cm.



Cod. 664010  
**Art. PILLY/120**  
Pair of aluminium columns for photocells, height 100 cm.

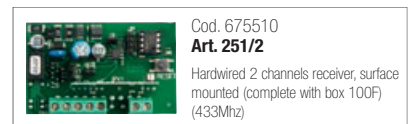

Cod. 675510  
**Art. 251/2**  
Hardwired 2 channels receiver, surface mounted (complete with box 100F) (433Mhz)



Cod. 629290  
**Art. BAT**  
Rechargeable batteries kit for 24V operators, 12V - 1,3Ah, complete with wiring cables



Cod. 681050  
**Art. Green Energy**  
Solar power kit complete with art. CHARGER



Cod. 665000  
**Art. BLINDOS**  
Safety enclosure to place external unlocking device handle



Cod. 136024  
**Art. 1100**  
Horizontal electric lock complete with double cylinder and horizontal selvaige art. 109A



Cod. 136006  
**Art. 110V**  
Empty electric lock (without European cylinder) with ground selvaige art. 109

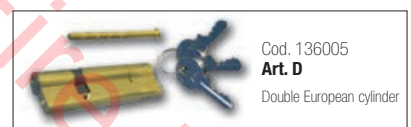

Cod. 136005  
**Art. D**  
Double European cylinder



Cod. 136004  
**Art. M**  
Half European cylinder



Cod. 679140  
**Art. 100GG**  
Large PVC box, suitable to include any other DEA boxes, to grant a better protection and isolation.

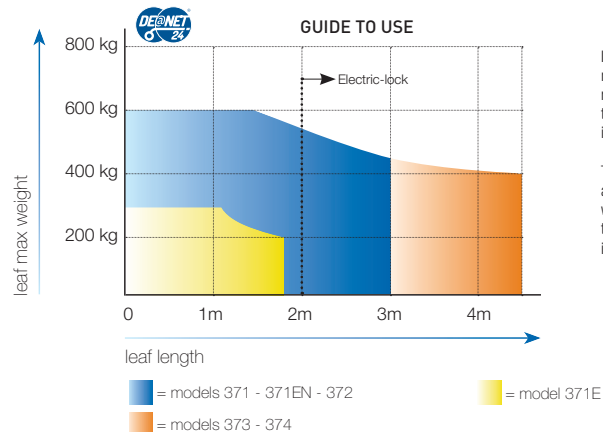
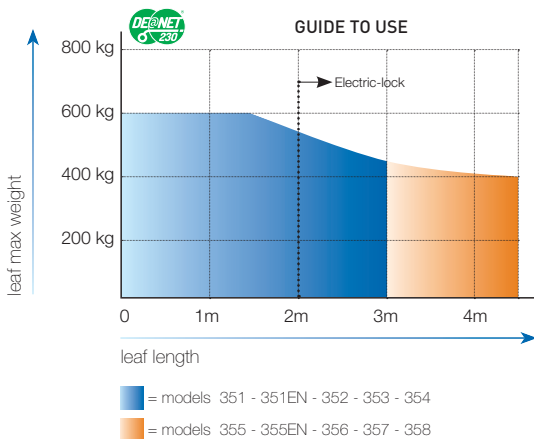

If the leaf length is bigger than 2 meters or if you use reversible models you must install the electric-lock to block the gate in closed position

The height and the leaf structure, as well as the presence of strong wind, can cause the reduction of the value of the data contained in table.