

## OPERATIONAL NOTES FOR CONCEPT FIRE PANEL.

### NOTE

ON NEW FIRE PANELS, POSITION 1 ON THE SIX WAY INTERNAL OPTION SWITCH IS TURNED ON, DISABLING THE ZONAL SOUNDERS. TO ENABLE ZONAL SOUNDERS TURN OFF.

#### Operation of fire panel.

Normal operation: The green LED is illuminated indicating system healthy. All other LED's are off.  
Fire condition: Triggered off by a smoke detector or a break glass operation and is indicated by a red LED showing common fire and a red LED showing the zone in fire, accompanied by a constant tone from the panel and the operation of zonal sounders and sounder circuits.

#### Evacuate.

Operation of the evacuate or remote evacuate will trigger all sounders. The remote evacuate is a none latching input.

#### Silence.

To silence the sounders, press the silence button having first enabled the controls with the keyswitch. The sounders will cease to operate and the panel buzzer will pulse to indicate that the silence has been pressed. Auxiliary relay ( reset on silence ) will be reset.

#### Reset/ Lamp test.

The reset button will perform a lamp test of all LED's which should illuminate in sequence. It also resets the processor, resets the detectors, resets any fire condition that may be latched, resets buzzer if in operation, resets all auxiliary relays and resets sounders. If a fire condition or fault persists after reset, the circuit will redisplay the condition. If a fire condition exists the sounders will come on even if they were silenced previously. When a fire condition is indicated, the source of the detection should be investigated before reset is pressed in order to locate the smoke detector triggering the system. ( the smoke detector operating will have an LED illuminated on it.)  
If there is a residue of smoke in the area, the smoke detectors may reactivate after reset, In this case try again after a short time.

#### One man test

In this mode the unit will reset every 10 seconds. This will enable the detectors to be tested without the need to return to the unit to reset the detectors. Whilst in this mode, the fault lamp will come on and the buzzer will pulse. The silence function will not operate.

The zones, sounders, relays and remote input can all be isolated from the front controls by pressing the mode button and selecting or clearing the operation by pressing the set/clear key. A constant indicator shows that function has been selected. (A flashing indicator shows it has been cleared).

To isolate a zone first select the zone isolate function, further presses of the mode key enable isolation of the individual zone in the same manner as before.

When the appropriate isolation has been selected, pressing reset returns the panel to normal operation. If no keys are pressed for 25 seconds the panel will automatically reset.

One man test may be selected also by pressing the mode button and selecting or clearing by pressing the set/clear button, followed by pressing reset.

See the Mode selecting/ clearing instruction sheet for further detail.

The zones are monitored for short circuit, shown by a constant LED on zone fault. open circuit gives flashing LED on zone fault, flashing in time with the zone indicator LED. Head removal zone fault gives flashing LED in time with zone indicator LED but reverse flash rate to open circuit.

Sounder circuits are also monitored for open /short circuit in the same manner.

Sounder fuse fault gives flashing zone indicator and constant fuse indicator.

Failure of the fuse does not effect zone monitoring.

The fuses and head removal are monitored every 25 seconds.

The sounder circuits are monitored for short circuit, constant LED on sounder fault and flashing LED for open circuit.

Internally there is a set of six switches to alter the functions of the panel.

#### Pos 1

##### Zone sounders inhibit

In this mode the zonal sounders are turned off. This may be selected when the panel is used as a conventional panel where the sounders pulsing signal may cause a problem.

#### Pos 2

##### Pre 1988 mode

In this mode the panel operates to pre 1988 specifications, i.e. a short circuit gives a fire condition. This mode can be used when a panel is used with old detectors or even a mixture of old and new detectors. Note that in this mode there is no head removal and no zonal sounders operation.

#### Pos 3

##### Non latch zone 1

In this mode zone 1 will not latch. This mode is used to operate the fire alarm panel from another panel, say in a landlord/tenant application. The landlord's panel can trigger a number of other panels to show fire, but they are reset when the landlord's panel is reset.

#### Pos 4

##### None latch zone 2

In this mode zone 2 will not latch. This mode is used to operate the fire alarm panel from another panel, say in a landlord/tenant application. The landlord's panel can trigger a number of other panels to show fire, but they are reset when the landlord's panel is reset.

#### Pos 5

##### Sounder delay

In this mode in fire condition operation of zone sounders and sounder circuits 1 and 2 are delayed for two minutes. Sounders 3 and 4 are instant.

#### Pos 6

##### Zone 1 lamp and buzzer only

In this mode when zone 1 is triggered, will only give lamp and buzzer indication on the panel. No sounders or relays will be activated.

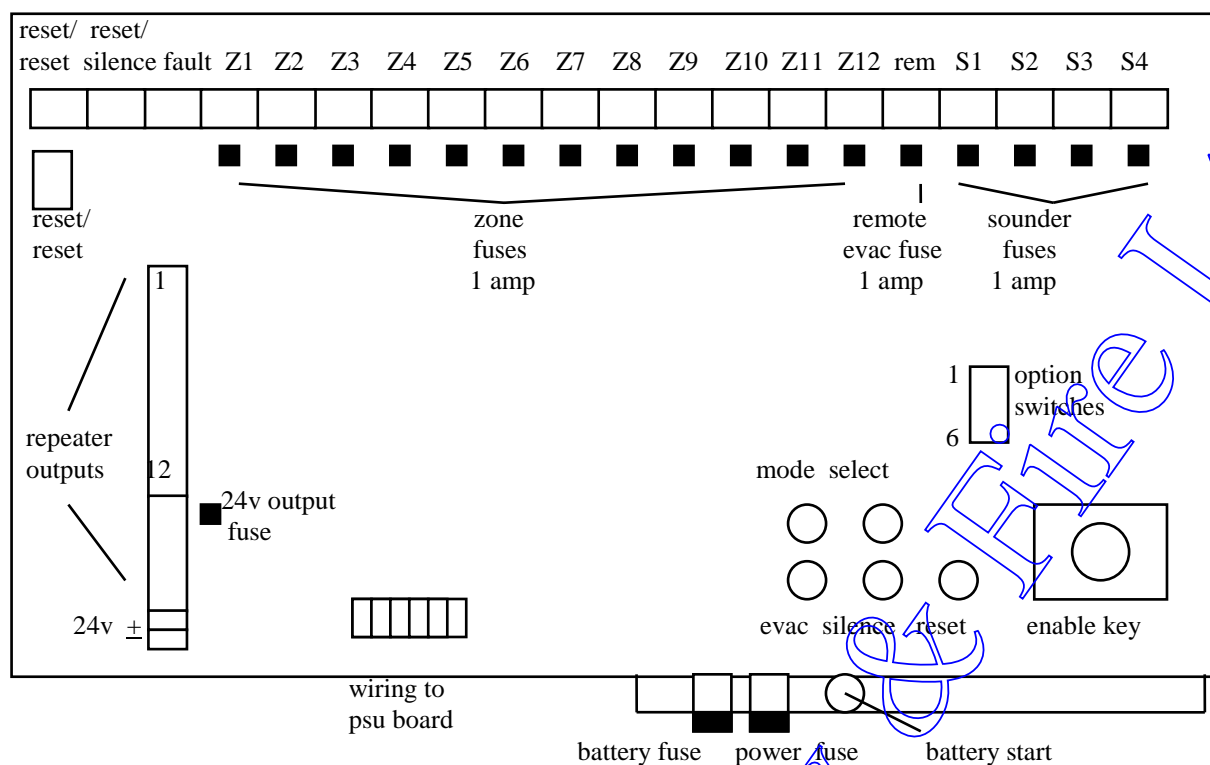

### Technical specifications.

- Detector zones and sounder circuits - 4K3 end of line resistor.
- Up to 12 zones. 20 detectors per zone, 15 two wire sounders per zone with a maximum of 70 two wire sounders across all zones.
- 4 Sounder circuits - normally reverse polarity, in alarm 24v fused at 1 amp per sounder circuit.
- Power supply rated at 2 amps.
- Battery charger capable of charging 2 x 12v 7AH batteries.
- Charging voltage 27.6 volts.
- Batteries protected from full discharge by battery protect relay. This relay prevents the panel being powered up on batteries only at commissioning. To override this there is a push button on the back board to start the panel on batteries only. The battery and power supply fuses are also situated on this rear board.
- Control panel consumption 110 ma max.
- 2 Auxiliary relays, with 3 sets of volt free changeover contacts rated at 2 amp max. two operate on fire, reset on reset. One operates on fire, reset on silence.
- 1 Fault relay, with one set of volt free changeover contacts.
- 24 volt d.c supply for beam detectors etc.
- Repeater output connections.

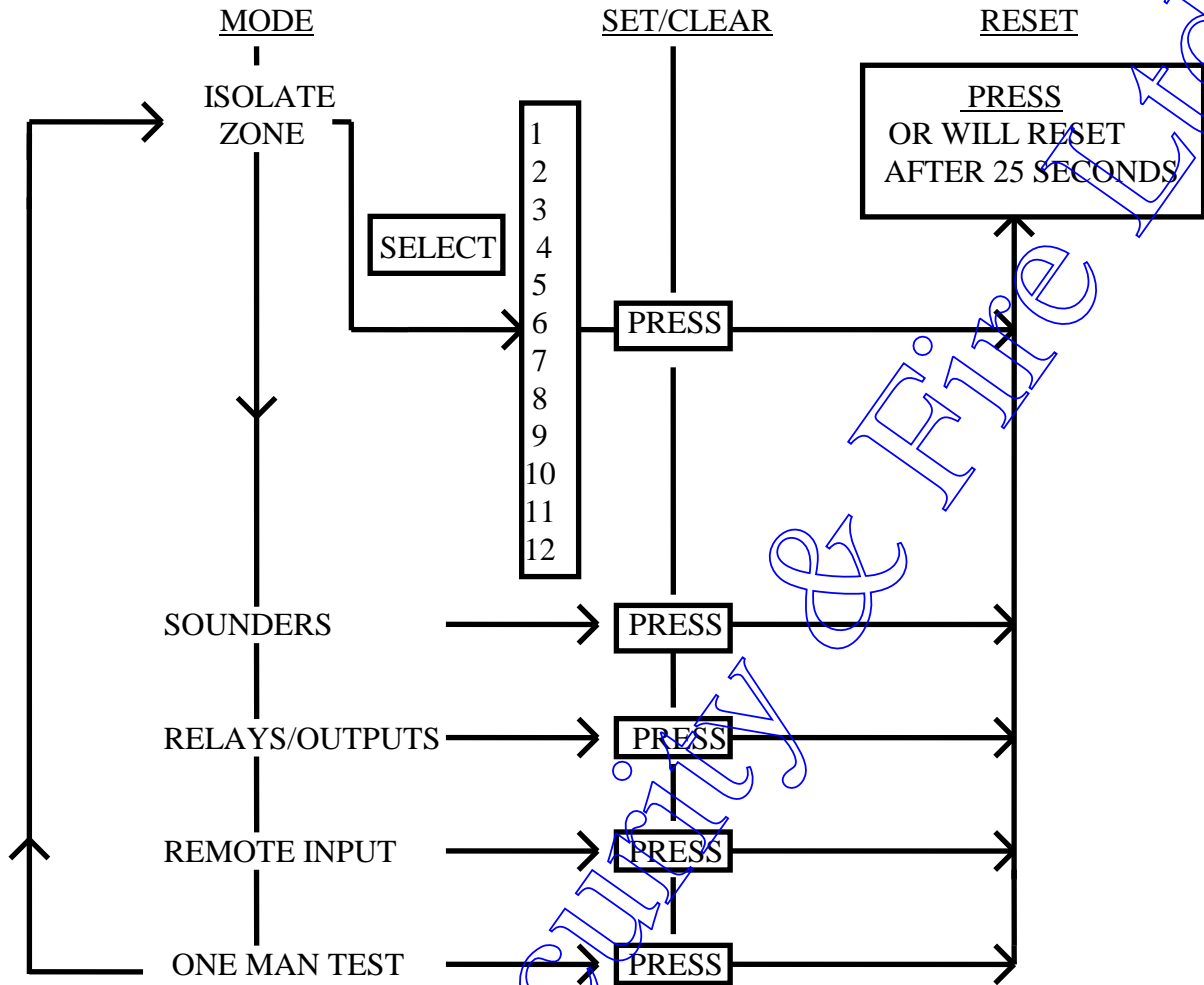
MODE SELECTING / CLEARING.To select zone isolation

1. First press mode, Note, the zone isolation light will be flashing.
2. Press set/clear, the light will become constant.
3. Press mode, the zone light will now be flashing.
4. Continue pressing the mode button until you get to the zone required.
5. Press set/clear, the light will become constant.
6. Press reset, The zone is now isolated.

To select other modes.

1. First press mode, Note, the light will be flashing.
2. Then continue pressing it, rotating round the options, until the one wanted.
3. Press set/clear, the light will become constant.
4. Press reset, the mode selected is now set.

To clear zone isolation.

1. First press mode, Note, the zone isolation light will be flashing.
2. Press set/clear, the light will become constant.
3. Press mode, the zone light will now be flashing.
4. Press reset, the mode is now cleared.

To clear other modes.

1. First press mode, Note, the light will be flashing.
2. Press reset, the mode is now cleared.

4K3 End of line Monitoring resistor on last device on each zone.



4K3 End of line Resistor on the last Device. A minimum of 2 sounder Circuits must be used.



Remote evacuate. This input can be used to sound the alarms from a remote source by introducing a 470 ohm resistor across the line. A 4K3 end of line resistor must be fitted.

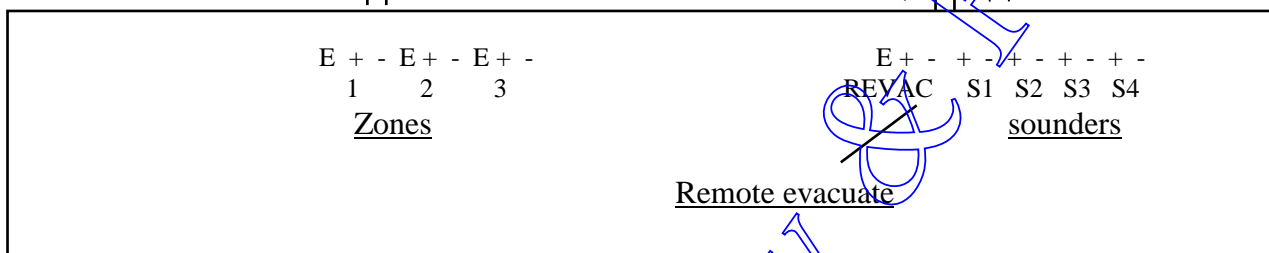

CONVENTIONAL PANEL CONNECTIONS.

4K3 End of line Monitoring resistor on last device on each zone.



4K3 End of line Resistor on the last Device.



2 wire sounder

Remote evacuate. This input can be used to sound the alarms from a remote source by introducing a 470 ohm resistor across the line. A 4K3 end of line resistor must be fitted.

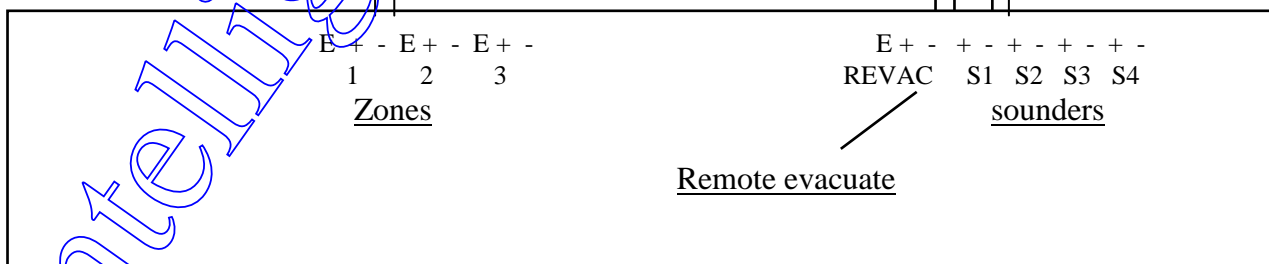

2 WIRE SOUNDER PANEL CONNECTIONS

**WIRING DIAGRAM FOR FULLEON 2 WIRE SOUNDERS**

APPOLLO SERIES 60

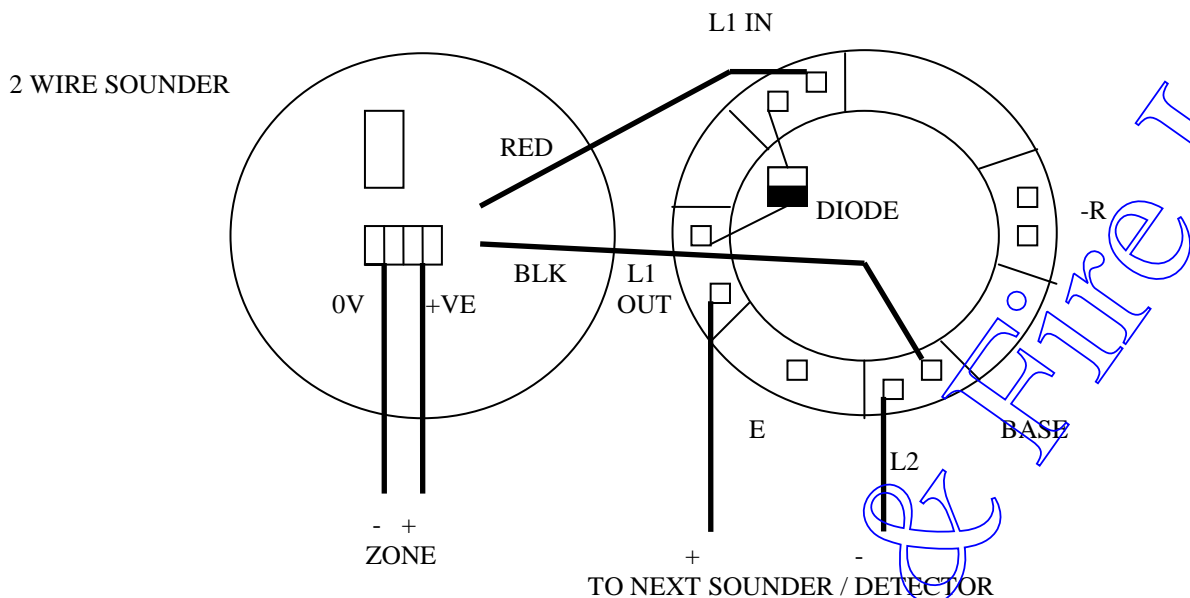

THE DETECTOR BASE IS SCREWED ONTO THE SOUNDER USING THE SCREWS PROVIDED.  
 CONNECT THE WIRES ON THE SOUNDER TO L1 IN AND L2 ON THE DETECTOR BASE AS SHOWN ON THE WIRING DRG.  
 UP TO 15 TWO WIRE SOUNDERS CAN BE WIRED TO EACH ZONE, WITH A MAXIMUM OF 70 TWO WIRE SOUNDERS ACROSS ALL ZONES.  
 AN END OF LINE 4K3 RESISTOR MUST BE FITTED ON LAST SOUNDER OR DETECTOR.

HOCHIKI YBN-R/4SK BASE

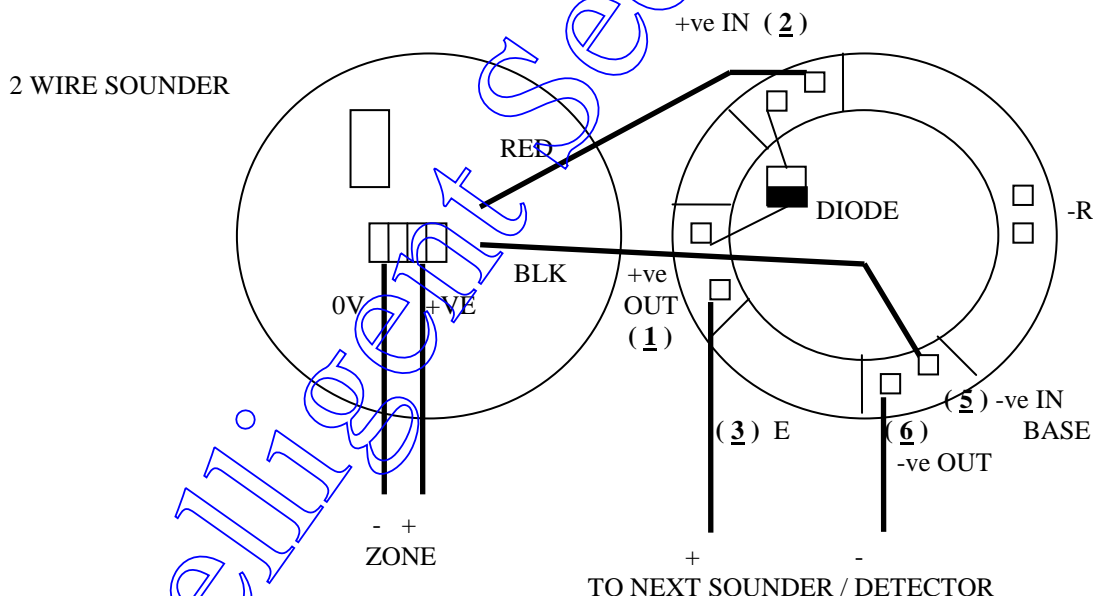

THE DETECTOR BASE IS SCREWED ONTO THE SOUNDER USING THE SCREWS PROVIDED.  
 CONNECT THE WIRES ON THE SOUNDER TO 2 AND 5 ON THE DETECTOR BASE AS SHOWN ON THE WIRING DRG.  
 UP TO 15 TWO WIRE SOUNDERS CAN BE WIRED TO EACH ZONE, WITH A MAXIMUM OF 70 TWO WIRE SOUNDERS ACROSS ALL ZONES.  
 AN END OF LINE 4K3 RESISTOR MUST BE FITTED ON LAST SOUNDER OR DETECTOR

## Installation and Commissioning

### General

This section should be read fully before commencing wiring and installation of the fire panel. The FireSense range of fire panes has been designed to comply with BS 5839 : Part 4 : 1988. Fire detection installations should be designed in accordance with BS 5839 : Part 1 : 1988. The choice of cables used is dependant on the installation and should comply with BS 5839 : Part 1 : 1988. Cables should be installed in accordance with the current edition of the IEE Wiring regulations (Regulations for electrical installations, published by the Institute of electrical engineers) (BS 7671 : 1993).

### Sounder Wiring

Mineral insulated copper cable or similar fire proof can mechanically resilient cable should be used for alarm sounder circuits, as indicated in BS 5839 : Part 1 : 1998. Section Two 17.

A minimum of two sounder circuits should be used in each installation to comply with BS 5839 : Part 1 : 1988

Sounder output circuits should be wired as continuous pairs with no spurs or tees.

An end of line device should be fitted to each sounder circuit as shown in Fig. 1.1. below.

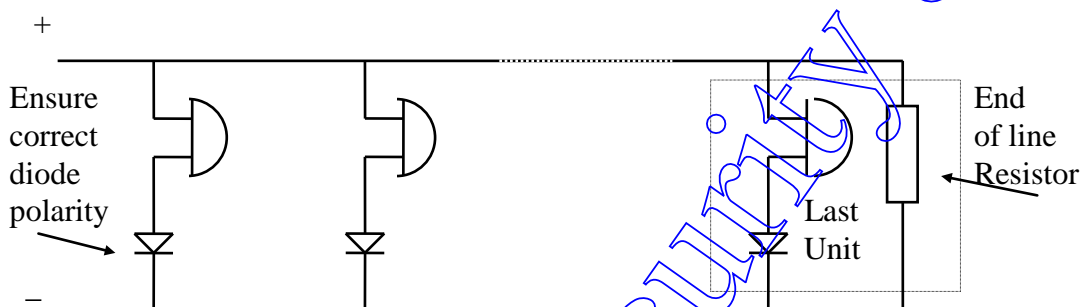

Fig. 1.1 Typical sounder circuit

### Detector Wiring

The cable used is dependant on the installation, as indicated in BS 5839 : Part 1 : 1988 Section Two 17. An end of line device should be fitted to the end of each zone circuit.

Unused zones require an end of line device connecting across the zone input terminals to prevent an open circuit fault from being indicated on the control panel.

When the detector removed facility is required a diode should be fitted in each detector base as detailed on Fig. 2.2 taking care to observe the correct polarity.

Refer to individual manufacturers data for details on detector terminals and wiring, some manufacturers allow for an in-line device to be fitted in the negative line.

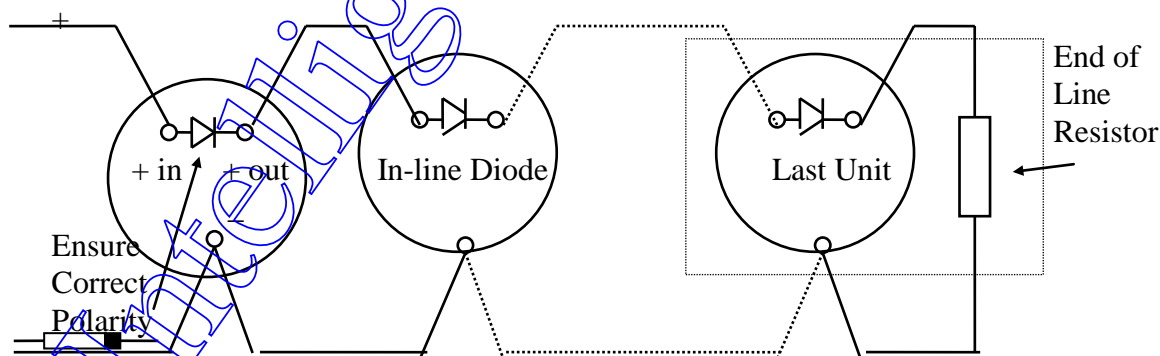

Fig. 1.2 Detector Wiring diagram

### Call points

To comply with BS 5839 : Part 1 : 1988 Resistive call points should be used on the installation to differentiate between a fire condition (a resistor ) and a short circuit. Old installations work on a short circuit as a fire condition. If a FireSense panel is to be used on an old installation e.g. short circuit call points either resistors are needed in line with the call points (470R or 680R) or alternatively, if it is not a requirement to bring the system up to date the panel can be switched to treat a short circuit as a fire condition. Failure to do this will cause the panel to go into short circuit instead of fire, on operation of the call point.

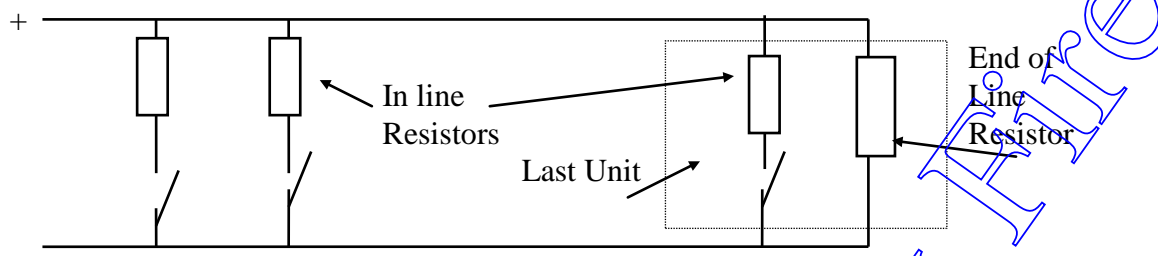

Fig. 1.3 Call point Wiring diagram with in line resistor

Call points normally come with integral resistors and so no extra resistors are required.