

INSTALLATION AND CONNECTION OF THE DDA compliant video intercom



General points

The built-in call panel (ref.: 02-0200-EN) is a multifunctional call panel which offer **phone call** from the visitor to the resident's telephone.

This call panel is available in a "**Stainless-steel**" coloured finish and is **flush-mounted**. It is configured using the following website: **www.intratone.com** in the "management website" tab

It must be connected to the following "real-time" **central units**:

- 2 to 4 doors (ref.: 03-0101-EN)
- 1 door (ref.: 03-0102-EN)

Ideal for installation near an entrance gate; four opening methods are possible:

- By using an authorised badge
- By typing in a specific code
- By calling a resident using the call panel, who then opens the gate using a key on his/her telephone
- Using a "mobilekey".

Product description:

The Visio telephone intercom with scrolling name-display consists of:

- ✓ A 12-keys keypad and backlit LCD screen
- ✓ A "Trade" call button available on time range
- ✓ A video camera.
- ✓ A proximity reader.
- ✓ Built-in speech synthesiser: "Call in progress"; "Door open", etc.

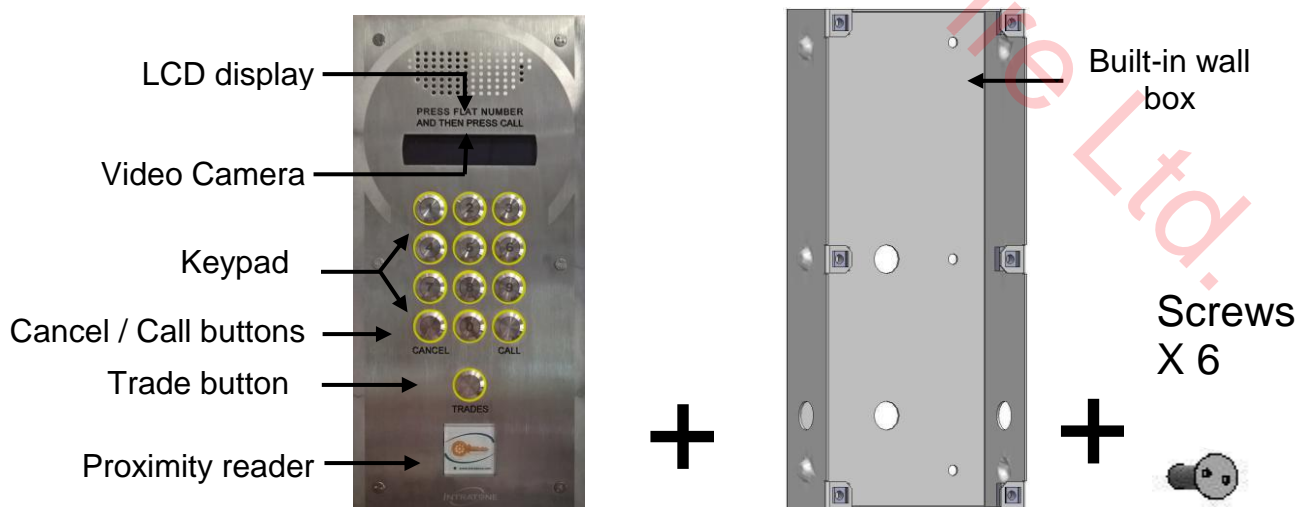

Contents

GENERAL POINTS	1
CONTENTS	2
DIMENSIONS AND ASSEMBLY	3
A) DIMENSIONS OF CALL PANEL	3
B) BUILT-IN BOX DIMENSIONS	4
WIRING	5
A) WITH CENTRALE UNIT 1 DOOR	5
B) WITH CENTRALE UNIT 2 DOOR	6
EQUIPMENT CONFIGURATION	7
A) GENERAL POINTS	7
B) CONFIGURATION WITH A RESIDENTIAL CENTRAL UNIT, 03-0101-EN	7
C) CONFIGURATION WITH AN INTRACODE 03-0102-EN CENTRAL UNIT	8
POST-FITTING CHECK	9
D) ON THE PANEL	9
E) DOOR CONNECTION	9
F) CALLS	9
A) KEYPAD CODE	9
DIAGNOSIS IN THE EVENT OF A FAULT	10
CERTIFICATE OF CONFORMITY	

Dimensions and assembly

A) Dimensions of call panel

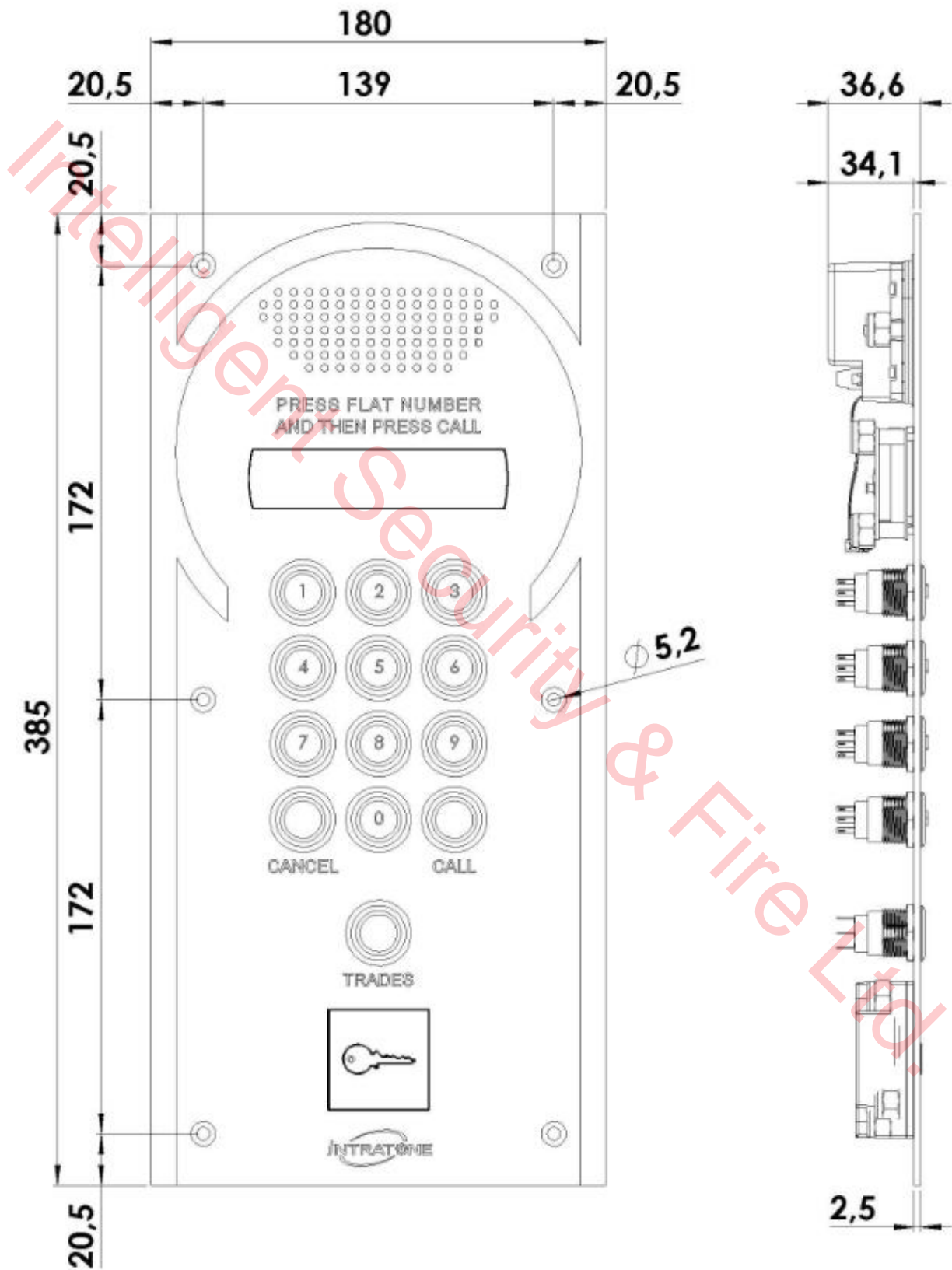

B) Built-in box dimensions

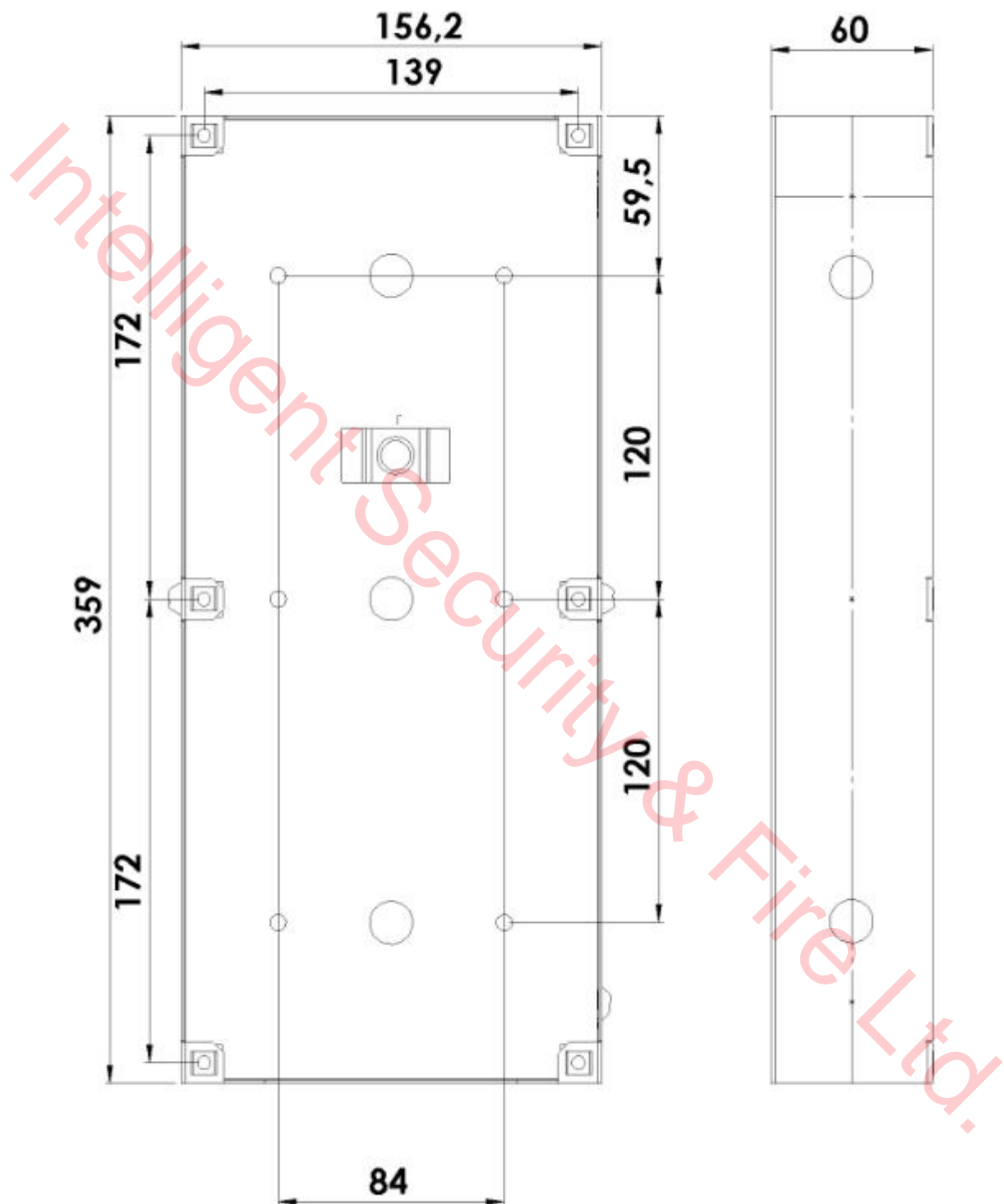

WIRING 03-0102

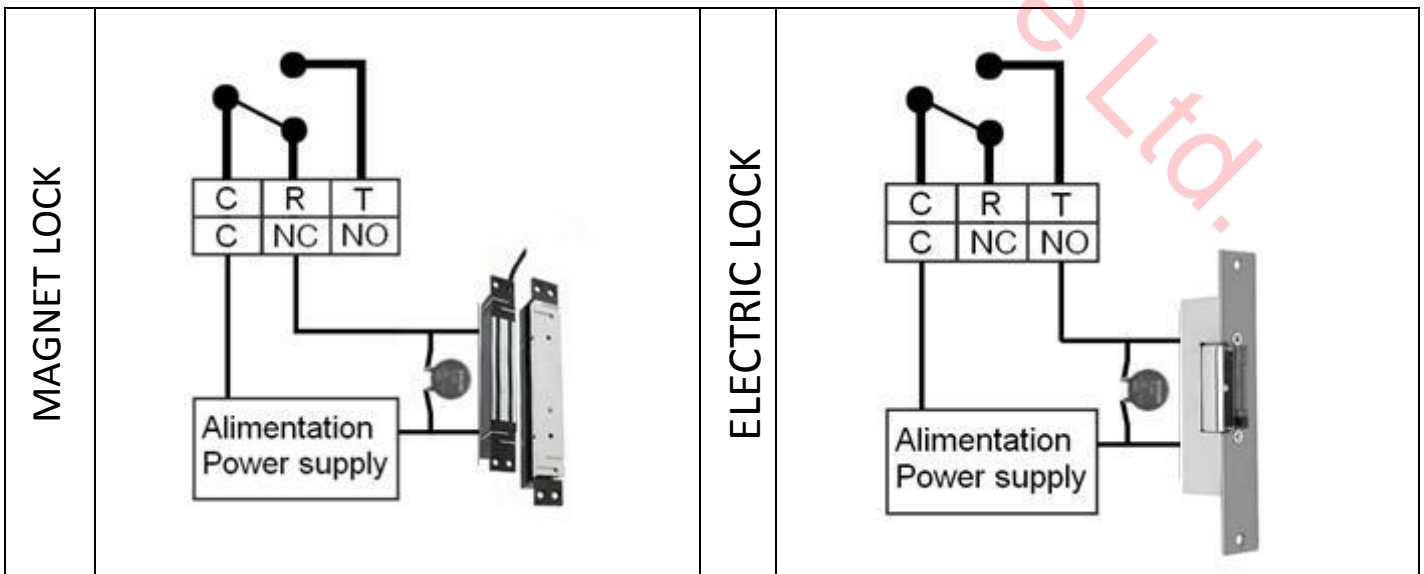
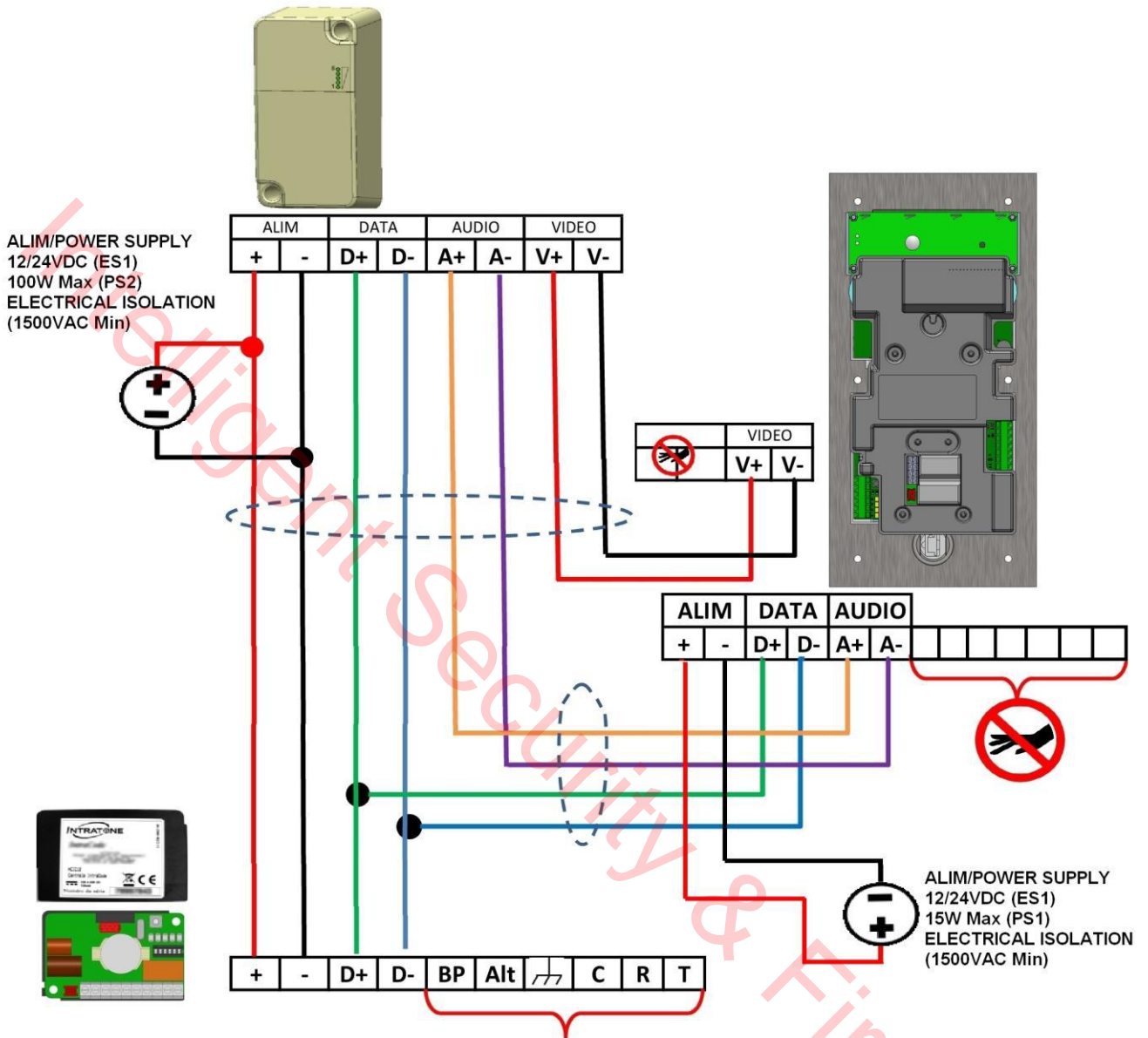

WIRING 03-0101

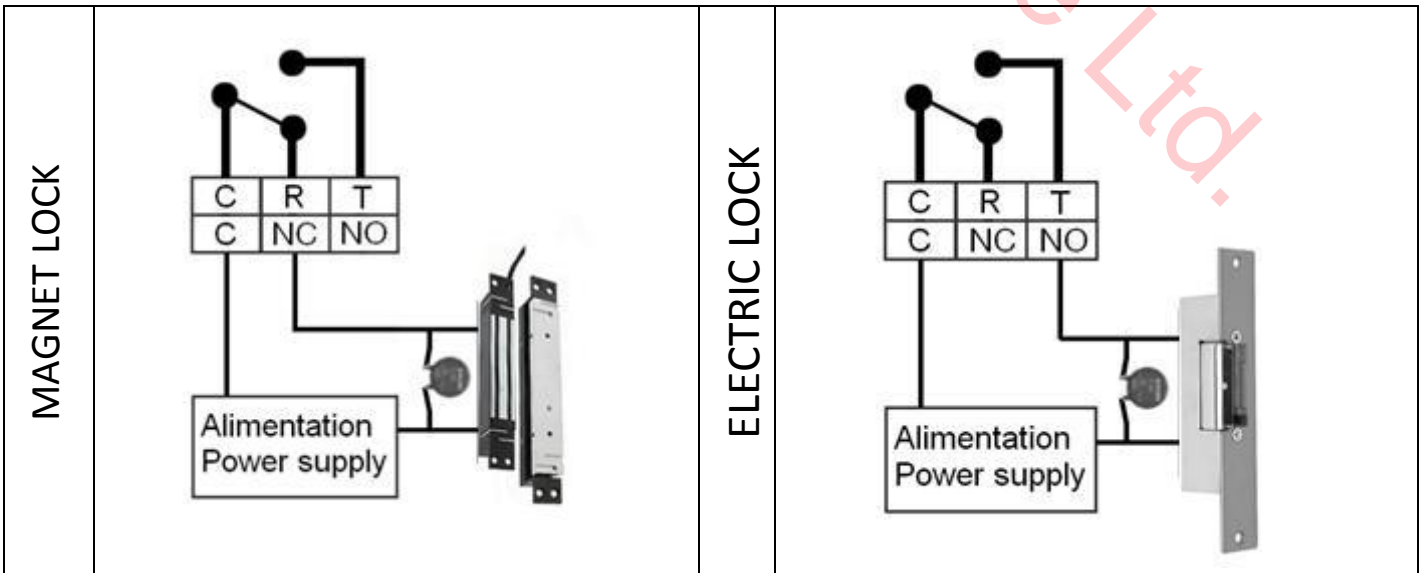
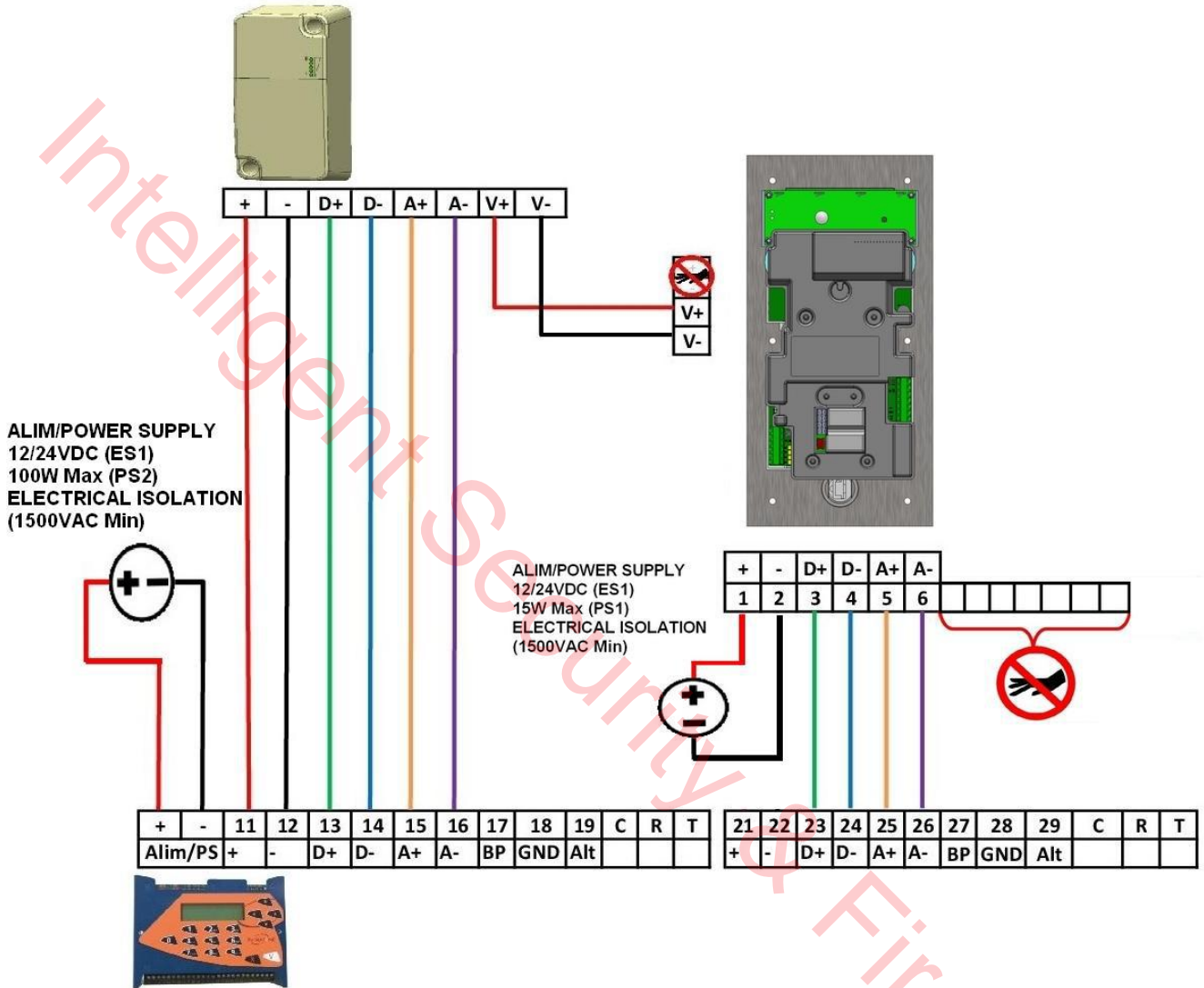

Equipment configuration

A) General points

INTRATONE call panels are mainly configured on the [www.intratone.com website](http://www.intratone.com) in the **"management website" tab**.

Nevertheless, some settings can be changed on-site:

- Configuration of the push button.
- Configuration of the door-opening time.
- Panel sound volume

B) Configuration with a Residential central unit, 03-0101-EN

(See central unit guide 03-0101-EN V233-5001-XX)

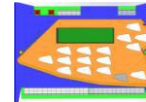

The settings mode is available on the central unit keyboard:

- Check that the welcome message is scrolling on the LCD
- Press the **"V"** key then the **"Enter password"** menu appears.
- Type the serial number of the 03-0101-EN central unit (000xxxxx).
- Validate with the **"V"** key. « **You are in menu settings mode** »

Menu options in settings mode:

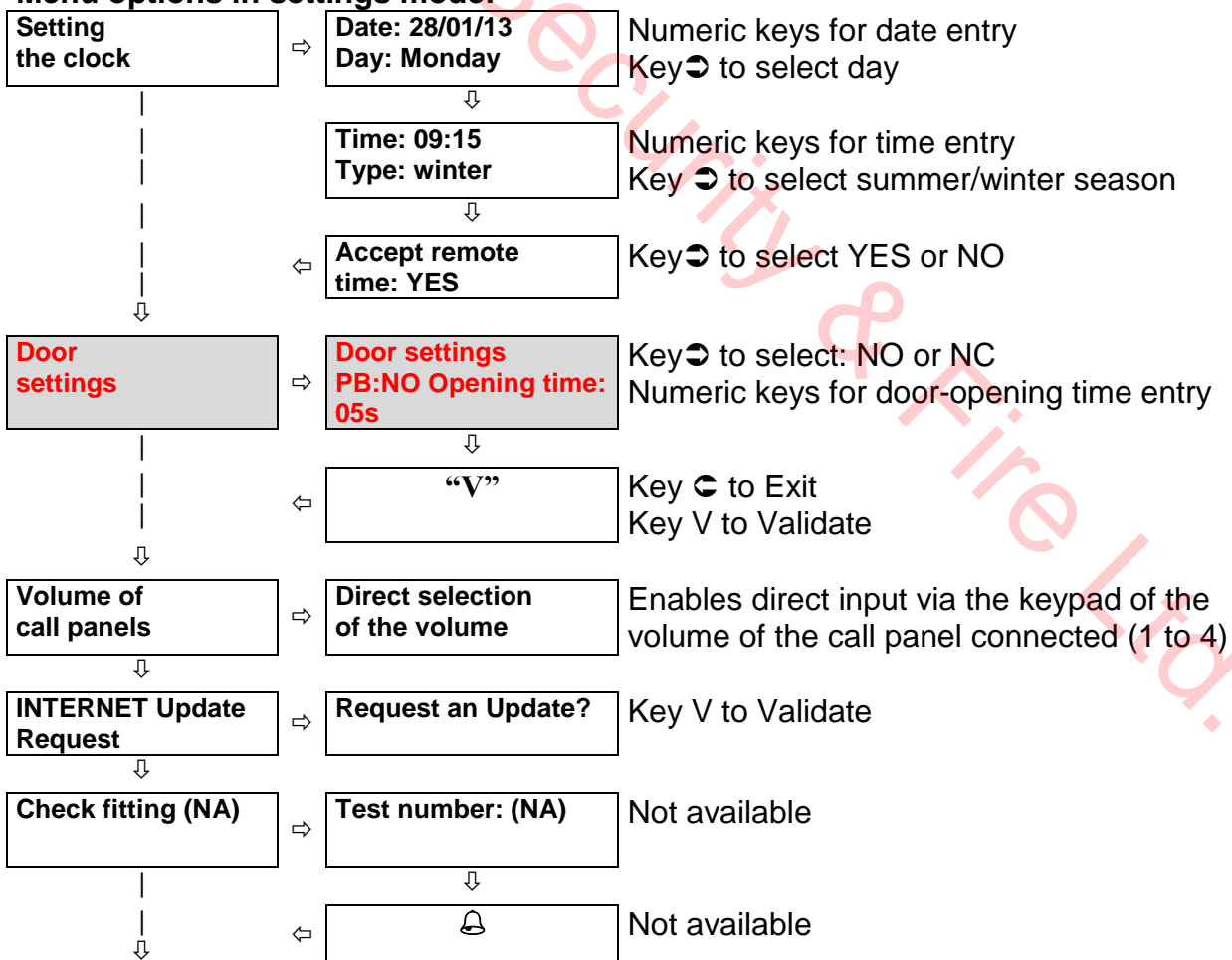

c) Configuration with an Intracode 03-0102-EN central unit

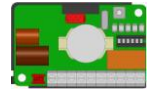

Presets selection is performed by switches actuation on the Central unit card (on the right hand side of the battery)

- ❖ Switch 1 to 3 : NA
- ❖ Switch 4 and 5 combination graduate the opening time

Sw4 :	on	5 sec	On	10 sec	Off	20 sec
Sw5 :	on		off		on	

- ❖ Switch 6 : select door open PB type
Sw6 : **on** NO **off** : NC

Post-fitting check

Before leaving the fitting, the following points should be checked:

A) *On the Panel*

- ❖ Display shows the welcome message
- ❖ Check that the keypad keys (0, 1, 2 →9) are working.
Procedure:
 - Press any key to display it
 - “Cancel” key return the display to the welcome message.
- ❖ Check that the keypad keys are backlit.

B) *Door connection*

- ❖ Check door opening with the “TRADE” push button (during opening time range)
- ❖ Check door opening using a fob
- ❖ Check door opening using a keypad code :
 - Keep pressing “trade” pb until display “KEYPAD CODE”
 - Select a valid keypad code and as soon as it’s full selected simultaneously
 - the door will automatically opened
 - a message display and sound message "door open" will be turned on
(See Test Procedure in the central unit guide)

C) *Calls*

- ❖ To call a resident, you have to select his flat’s number on the keyboard and then press “call pb” to validate your selection or “cancel pb” in any case if you want to reset or make a new selection
- ❖ “Trade pb” is dedicated to offer a free acces for trades during a time range. This function has to be configured on the website in “Panel parameters/ Call button time range”.
- ❖ Check the quality of a call by a visitor to a resident:
 - Audio Call
- ❖ Check that, during the call, the resident can open the door by pressing the * key on his/her telephone

(See Test Procedure in the central unit guide)

A) *Keypad code*

- ❖ A keypad code can be configured on the website in “Manage entrance codes/keypad
To use a keypad code on the Intercom, you have to keep on the “Call pb” until “keypad code is displayed” and then select one of keypad codes available

In the case of a fitting with an 03-0102-EN central unit
The serial number (7XXXXXX3) of the central unit will be used on the website to configured the installation.

diagnosis in the event of a fault

<i>What is the fault?</i>	<i>What is causing the fault?</i>	<i>How to fix the fault!</i>
Message on the display: « Communication error »	Incorrect cabling on the D+ and/or D- terminals	- Check cabling between the 3G unit, the call panel and the central unit: D+ and or D-. - The display should show the welcome message.
Keys and display not backlit	- Incorrect cabling on the + and/or - terminals - Equipment fault	- Check cabling on the + and/or - terminals - Contact our technical support department
Keys backlit but not display (or the reverse)	Contact our technical support department	
The LCD screen does not turn on	Incorrect cabling on the + and/or - terminals	Check cabling between the central unit and the call panel: + / -
When swiping a badge, the green LED on the reader lights up but the door does not open .	- Relay on the central unit not working. - Cable to the door	- Check if relay sticks - Check cabling between the central unit and the door
If the call panel says "Call in progress" but the resident cannot hear the visitor	Incorrect cabling on the A+ and/or A- terminals	Check A+ / A- cabling
The call panel says "Unable to call" with no dial tone	Telephone network not available	Check cabling to the GSM unit and LED levels

☎ Contact our technical support department (+33 (0)251 655 529) ☎

CERTIFICATE OF CONFORMITY

Hereby, COGELEC declares that the radio equipment type **DDA compliant video intercom** is in compliance with Directive 2014/53/EU. The full text of the EU declaration of conformity is available at the following internet address: <http://certificates.intratone.com/>

Cabling:

The cables connected to the central unit must not be placed in the vicinity of other sources of electrical power (e.g. mains power supply).

Operating warranty:

The call panel is guaranteed for a temperature range of between **-20°C and +70°C** and for relative humidity not exceeding 70%.

End of life product recycling:



The panel and its accessories must not be disposed of with unsorted municipal waste but must be follow the WEEE (Waste Electrical and Electronic Equipment Directive) collection and recycling channel.