

Installation Manual & User Instructions

For

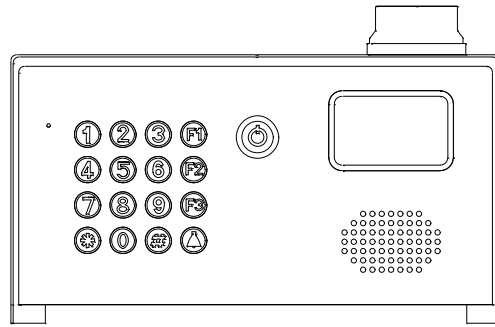
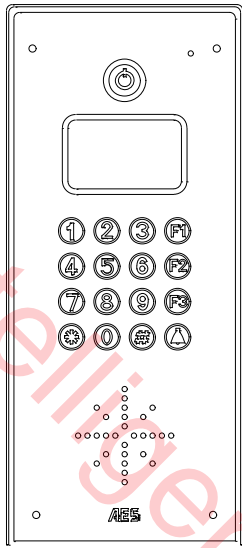

MultiCom 500

Multi resident GSM Intercom System

Contents

Section	Description	Page
1	Introduction	3
2	Getting started	3
3	SIM card	3
4	Wiring	4
5	Keypad / onscreen programming	5
6	Adding subscribers	5
7	Programming engineering features	6
8	PC Programming	8
9	Testing	8
10	SMS programming	9
11	Installation	10
12	Operation	10
13	Factory Default	11
14	Fault finding	11

1. Introduction

This GSM intercom uses the cellular networks to dial pre-programmed telephone numbers when an apartment number is called or family name is selected from the directory.

The 500 model will dial 3 numbers for 500 apartments. These numbers can be fixed line telephones or mobile cell phones or both.

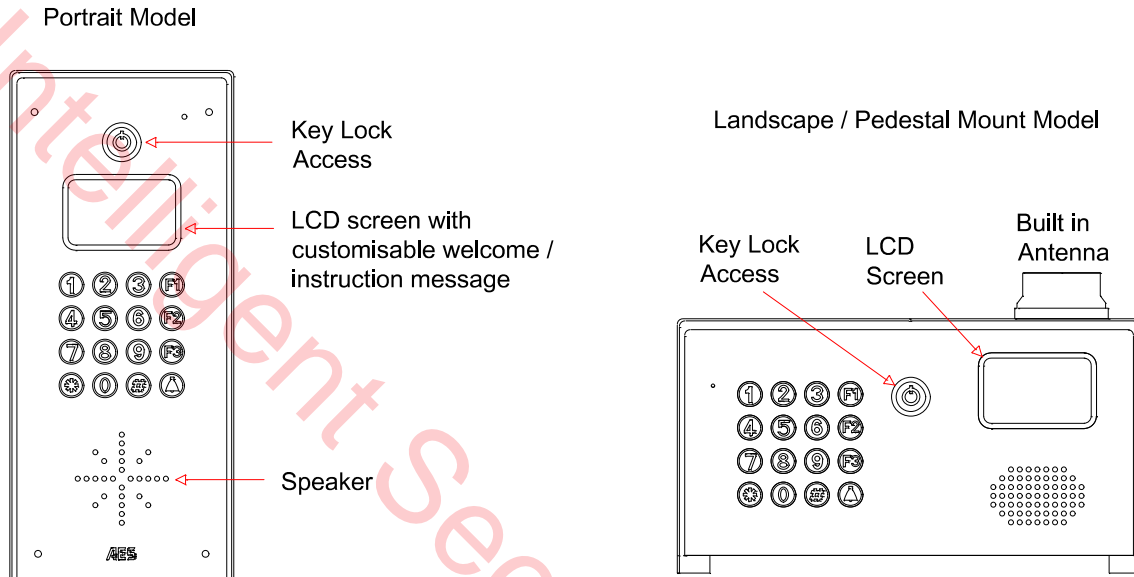

Any phone which receives a call from the intercom can activate a built in relay, which can be connected to an electric door release or automatic gate system.

2. Getting Started

- 1) Before installing the unit on site, PROGRAM AND TEST IT ON A BENCH. This system should only be installed by an access control professional, according to the wiring, fire and security regulations of your country. The system will not be covered under warranty by improper installation.
- 2) Use the keys supplied to open the front door to allow access.

3. SIM Card

- 1) The 100 model will operate on a standard 2G network. The 500 unit will also work on a 3G network as well as 2G.
- 2) For multi apartment systems experiencing heavy use, it may be advisable to purchase a contract SIM card with inclusive monthly minutes in a calling plan. A data SIM is not a requirement. The intercom calling time can be set to limit the calling time for each use, which will help ensure lowest possible calling times.
- 3) Ensure the SIM card has calling credit, and can make and receive voice calls in a mobile phone.
- 4) If the SIM has a pin code request active, disable this in a phone first.

- 5) If the SIM card was purchased along with a phone, then it may be locked to that phone. Ask your network provider to unlock the SIM so that it can be used in another device.
- 6) Insert the working SIM card and connect the antenna as shown below BEFORE connecting the power.

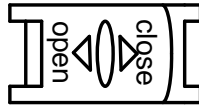

4. Wiring

Connect power to the unit as per diagram below.

Notes:

- 1) Do NOT use any other power supply other than the type supplied with the device.
- 2) Avoid installing the power supply more than 6 meters (18 feet) away from the intercom, otherwise voltage drop and noise on the power cables will cause unstable operation.
- 3) Do NOT connect this power supply to any electric locking device. Electric locks should be powered from their own power adaptor.

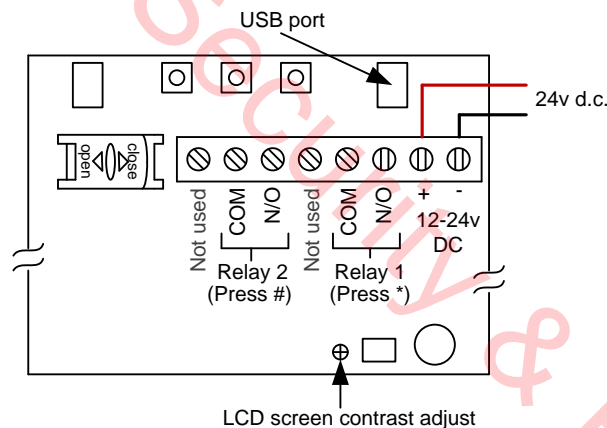

WARNING: Current draw when in operation spikes at up to 2 amps. Do not use alarm cable or CAT5 cable to connect power to this device.

- Up to 2 metres (6 feet) – Minimum 0.5mm² (20 gauge)
- Up to 4 metres (12 feet) – Minimum 1mm² (16 gauge)
- Up to 8 metres (24 feet) – Minimum 1.5mm² (14 gauge)



5. Keypad / On Screen Programming

To use the keypad programming method, the following keys are used...

F1 = Menu / Exit

F2 = Delete

F3 = Change abc/ABC/123 function key

* = UP

= Down

 = Enter / select

6. Adding Subscribers

To add a subscriber, first you must enter programming mode....

- 1) Press F1
- 2) Enter the default programmers code 123456
- 3) Press the bell / call button
- 4) Press * or # to select SUBSCRIBER
- 5) Press the bell / call button to select

6) The screen will look like this..
You may enter a flat or apartment address which can be between 1 and 6 digits long.

7) Press the bell / call button to proceed.

<p style="text-align: center;">Enter Subscriber</p> <p>ID: _____</p>
--

8) The screen will change to this. You can now enter individual name and telephone numbers for each subscriber. Move the cursor position by pressing * or #.
Use F3 to change from capital letters to small letters and numbers.

<p>Inh:N ID: 1 _____</p> <p>N: Mr Jones</p> <p>1: 0987654321</p> <p>2: 0123456789</p>

Use F2 to delete, call button to confirm, and F1 to exit again. 0 key can be used to insert a space.

7. Programming Engineering Features

Under the manager settings, the diagram below illustrates the settings which can be made on the unit...

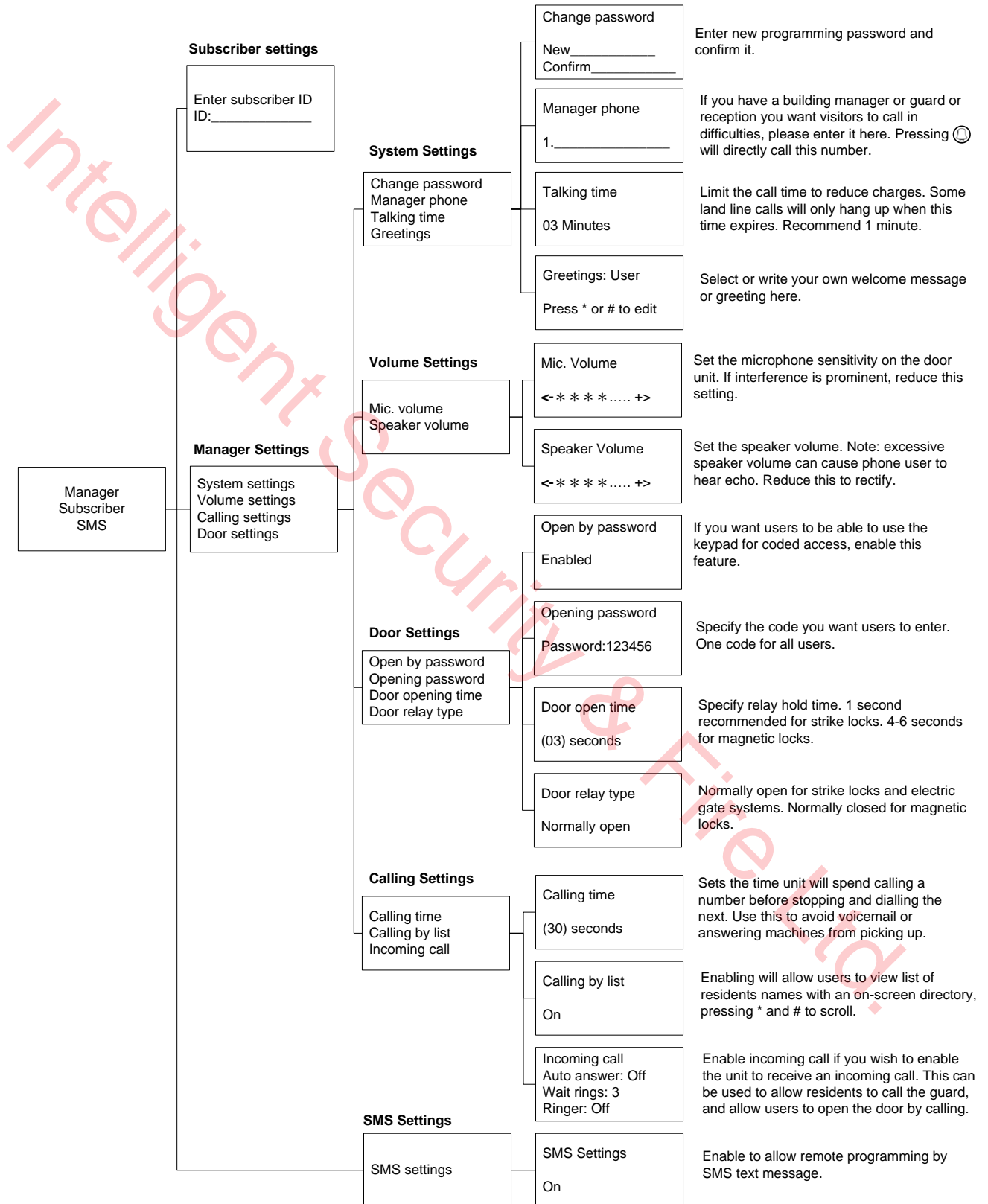

8. PC Programming

Software versions later than V4.04 can be programmed by PC software, via USB link. Please follow the steps as outlined...

- 1) Install the PC programming software. Contact your distributor for the installation file.
- 2) Power off the intercom, ensure SIM is inserted and antenna connected.
- 3) Connect USB cable to the port closest to the power connections.
- 4) Power on the intercom.
- 5) Open the PC programming software which will look as follows...

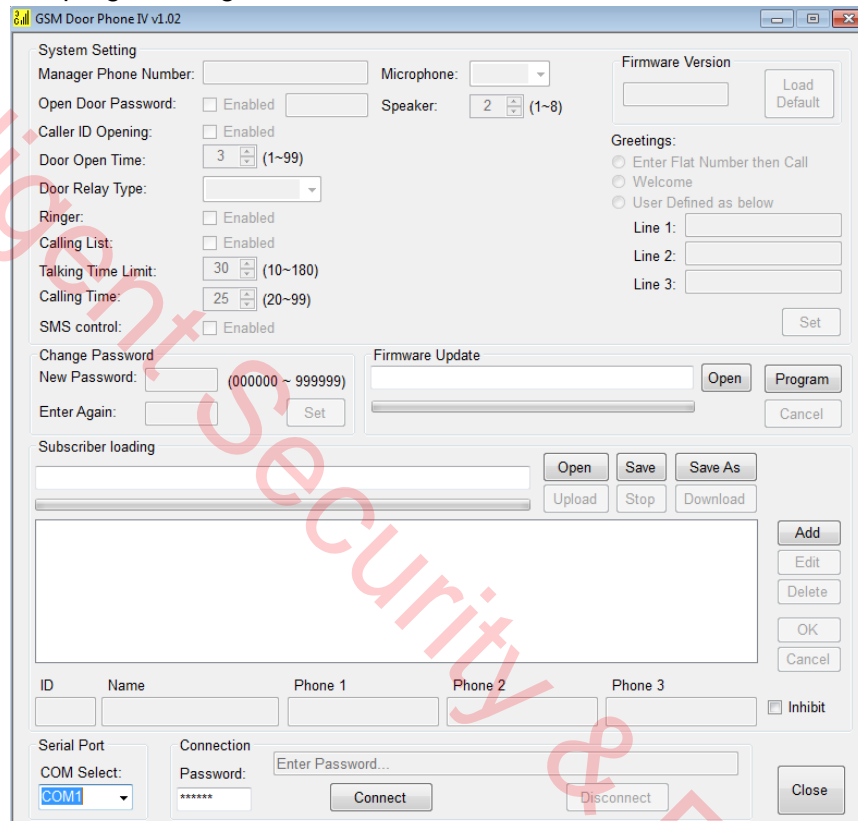

- 6) Select a COM port, enter the default password 123456 and press connect as shown below...

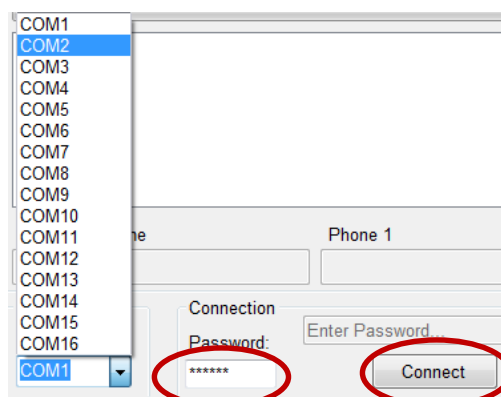

TIP: You may need to try this with several COM ports on your PC in order to find the exact COM port which is actually connected via USB to the intercom.

- 7) If any of the manager settings are changed on the software, you will then need to click on the SET button for that corresponding section in order for the new settings to be uploaded as shown...

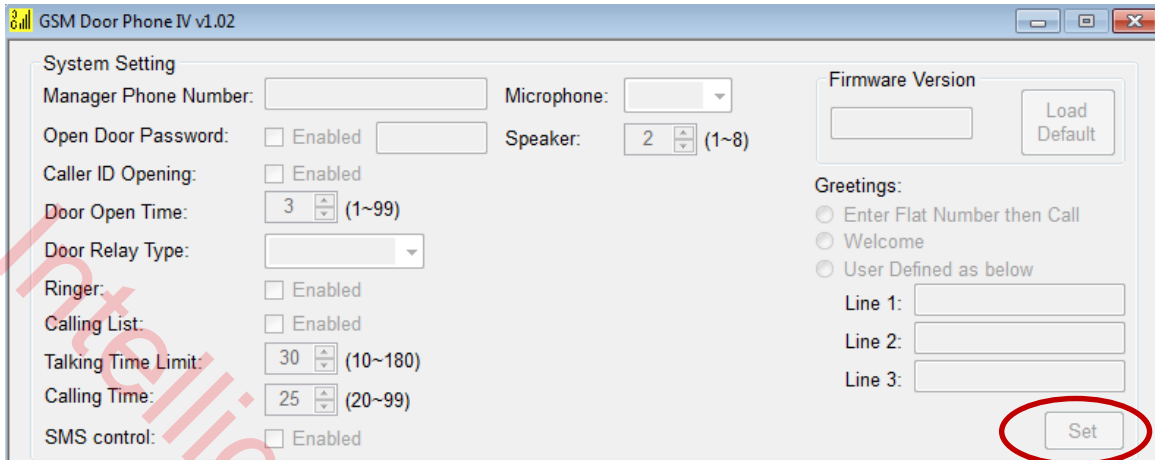

- 8) New subscribers or residents can be added, deleted or changed easily by this software. If the intercom has already previously been programmed, click DOWNLOAD, and the list will appear on screen. New subscriber details are added in the boxes along the bottom of this section in conjunction with ADD, EDIT and DELETE buttons at the side.

TIP: When finished, remember to click UPLOAD to save the new details to the intercom.

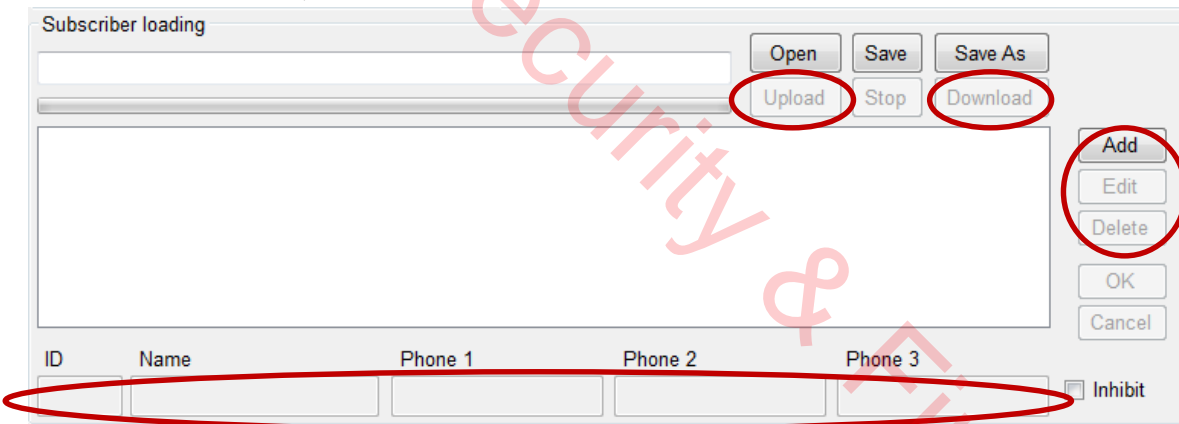

- 9) When all programming is completed, press DISCONNECT, then power off the intercom, disconnect the USB cable, and power ON again.

9. Testing

The unit should now be ready for testing.

- 1) Enter a test apartment number or select the test number from the on screen directory if it is enabled, and press call.
- 2) The unit should now be dialling the number.
- 3) Answer the phone, and check there is 2 way speech.
- 4) Press the * button. The screen should display: "The door is opened" and the relay should click.

9. SMS Programming

This system is capable of being programmed remotely by SMS. This is useful for adding or changing numbers particularly on an on-going basis.

Each SMS text must start with the pass code, followed by a #, followed by a command, followed by a #, followed by data in the following format..

Passcode#command#data#

9.1 Add a subscriber

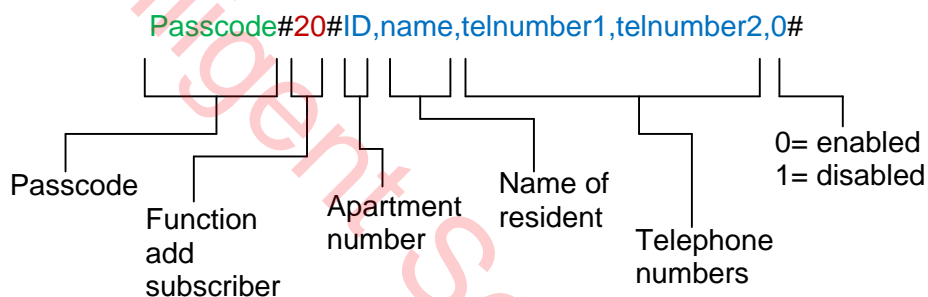

9.2 Change a subscriber

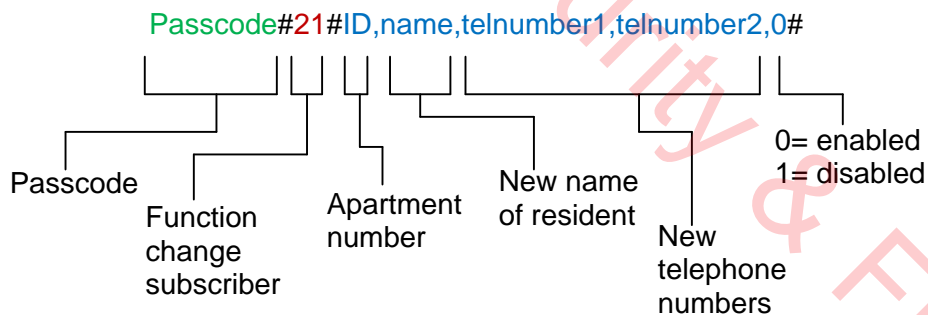

9.3 Delete a subscriber

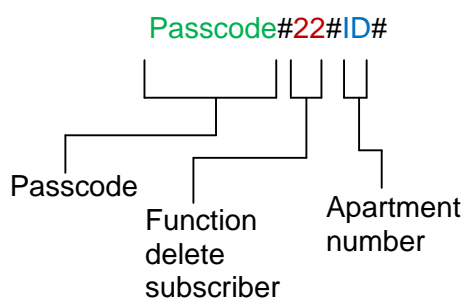

Additional SMS commands are shown below (SMS format assumes the standard default 123456 manager code has not been changed. If it has, replace this with the new code.

Description	Format of SMS	Comment	Default
Restore default passcode	123456#01#123456#		123456
Change passcode	123456#02#newcode#	6 digit code	N/A
Set managers phone number	123456#03#phonenumber#		N/A
Set talking time	123456#09#?#	? = minutes, 1-99.	3 mins
Set door open by password	123456#12#1#password#	1 = enable, 0 = disable	N/A
Set door open time	123456#13#?#	? = seconds, (2-99 sec)	3 secs
Set door relay type	123456#14#?#	0 = N/O, 1 = N/C	0 (N/O)
Set calling time	123456#15#??#	?? = seconds (25-99)	25
Calling list enable / disable	123456#16#?#	0=disabled, 1=enabled	0
Enquire subscriber	123456#23#?#	? = apartment address	N/A

10. Installation

You may now install the system onsite at the customer location and re-test the features. If the unit experiences problems onsite, this will likely be due to insufficient reception, or excessive power cable length.

TIP: Keep the antenna higher than the speech unit. This will reduce likelihood of radiation from the antenna distorting the audio quality.

11. Operation

Directory calling – If this is enabled, the visitor can press * or # to scroll through resident names and select the person they wish to speak to.

Apartment number calling – If the visitor knows the apartment number they wish to call, they can enter that apartment number on the keypad and press call. The resident can speak with the visitor and press * on their telephone keypad to trigger relay 1, or # to trigger relay 2.

Keypad access – If enabled, residents can enter a code on the keypad in order to gain access. Enter the code followed by F1.

Calling by phone access – If enabled, the intercom can be called from a subscriber phone and it will automatically trigger the relay 1 without answering and end the call.

Call the manager / reception – If a manager number is entered, pressing the call button will directly call the managers phone number.

12. Factory Default

The default settings can be restored on the unit by the following means.

Caution, factory default will clear all telephone numbers and subscriber names from the unit.

Press...

F2 * * * # # # Call

13. Fault finding

Q: The unit will not power up.

A: Check with a multi-meter the voltage on the terminals and check polarity.

Q: The unit is showing no carrier or no SIM.

A: Check the SIM card is seated correctly. Switch off power, remove and re-insert SIM carefully. Check the SIM has credit, can make and receive calls in a cell phone, and is not locked to a cell phone nor has a pin code request on it.

Q: The unit is leaving voicemail on users phones.

A: If users are pressing end call, the unit will automatically connect to the voicemail. If they want it to call the second number, they should simply ignore the call. If this is not the problem, decrease the timing of the "Calling Time" as per instructions.

Q: The unit is calling users, but when they press the * key the lock is not operating.

A: If you can hear the relay clicking when the * key is pressed, then the unit is working normally. The problem will then be with the wiring between the relay and the lock or gate system. Consult with a professional door or gate install company to ensure it is wired according to local fire, safety and electrical standards.

Q: The unit is calling users, but the relay does not click when they press * key.

A: Please verify that the user is indeed pressing the * key as many users get this mixed up with the # key on their phone. Check reception level. If reception is poor DTMF analogue tones may not work. Take steps to improve reception.

Q: Audio buzzing can be heard on user's phones.

A: Reduce the microphone gain on the door phone. Increase the height of the antenna, or move it further from the door station. Change network to improve reception. Low reception will cause increased radiation from the antenna, affecting the microphone audio quality.