

2N OMEGA 48  
2N StarPoint 500

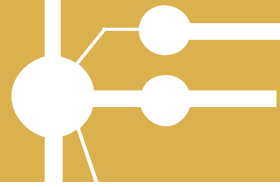

**USER'S MANUAL**  
**2N StarPoint 500**

version 2.0

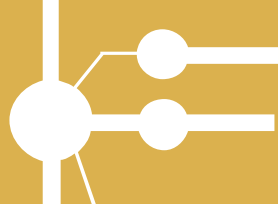

*Dear customer,*

*Congratulations on the purchase of the product **2N StarPoint 500**. This new product was developed and manufactured with an emphasis on maximum user value, quality and reliability. It is our desire that the 2N StarPoint 500 should give you complete and long satisfaction.*

Intelligent Security & Fire Ltd.

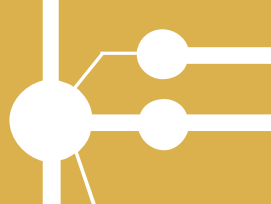

## CONTENTS

<b>1. Introduction</b>	<b>4</b>
1.1 Content of the Package	4
1.2 Getting Started	4
1.3 Accessories	5
1.4 Telephone Description	7
<b>2. Basic Operation</b>	<b>9</b>
2.1. Outgoing Calls	9
2.2. Incoming Calls	12
2.3. During the Call	12
2.4. Main Menu	13
<b>3. I would like to</b>	<b>15</b>
3.1. Set the Programmable Buttons	15
3.2. Respond to Missed Calls	16
3.3. Dial a Previously Called Number	16
3.4. Dial a Previously Calling Number	16
3.5. Reject an Incoming Call	16
3.6. Turn Down the Ringing Volume	17
3.7. Turn Off the Microphone Temporarily – To Prevent the Other Party from Hearing Me	17
3.8. Transfer a Call	17
3.9. Add a Call to a Conference	17
<b>4. Telephone Functions</b>	<b>18</b>
4.1. Lists of Calls	18
4.2. List of Missed Calls	20
4.3. List of Incoming Calls	20
4.4. List of Outgoing Calls	20
4.5. Internal Telephone Book	20
4.6. PBX Services	21
4.7. Intercom - TRF	22
4.8. Displaying the System Version	22
<b>5. Telephone Setup</b>	<b>24</b>
5.1. Programmable Buttons Setup	24
5.2. Description of the buttons	28
<b>6. Important Notices</b>	<b>32</b>

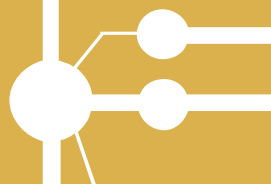

## 1. Introduction

2N StarPoint 500 telephone sets are digital system telephones. The sets (except for 2N StarPoint 500 Entry) feature a two-row display, programmable buttons, loudspeaker function (hands-free), and the option of additional accessories. The telephone sets are available in grey (arctic) or black (anthracite) color versions.

### 2N StarPoint 500 series types:



2N StarPoint 500 Entry    2N StarPoint 500 Economy, Standard    2N StarPoint 500 Advance

A telephone for common operations – 2N StarPoint 500 Entry: a simple digital telephone without display, with 8 programmable buttons, one-way speakerphone (no microphone for hands-free telephony).

A mid-range office telephone – 2N StarPoint 500 Economy, Standard: a basic type of digital system telephone with a two-row display and 12 programmable buttons. The Economy model features a one-way speakerphone (no microphone for hands-free telephony); the Standard model features two-way speakerphone function (it is equipped with a microphone for hands-free telephony). The Economy model is not equipped with interfaces for additional accessories (e.g., additional button modules).

A managerial telephone – 2N StarPoint 500 Advance: The most advanced telephone set of the 2N StarPoint 500 series. It is equipped with a two-row back-lit display, 19 programmable buttons and an interface for additional modules. It is also possible to connect a headset to the telephone set. The set offers a two-way speakerphone function (it is equipped with a loudspeaker and microphone for hands-free operation).

### 1.1 Content of the Package

The telephone set package includes:

- a telephone set
- a telephone cord
- User Manual on a CD
- a quick help card

### 1.2 Getting Started

Unpack the telephone set



Connect the receiver to the telephone set using the twisted cable (from the bottom – see the figure below)

Connect the telephone set to your telephone socket using the telephone cord supplied. *Note: The 2N StarPoint 500 telephone can only be connected to the dedicated socket.*



### Button name tags

For automatic name tag creation use the *PbX Configuration Tool*: on the button settings screen click the “Prepare for printing” button. After clicking this button, the pre-filled out print template will be created automatically.

You can also use the empty template included in the telephone set package to create name tags for the predefined programmable buttons.

For more information on button setup refer to chapter *Telephone Setup*.

### 1.3 Accessories

The 2N StarPoint 500 telephones can be enhanced with optional user comfort accessories such as additional button modules, headsets, etc. The additional accessories are to be connected from the bottom of the telephone set.

To add more buttons, you can add an assistant console (button KEY module) or an operator console (button BLF module) to your 2N StarPoint 500 Standard and Advance. By connecting these consoles serially you will obtain a large number of additional buttons. All buttons on the consoles can be set up in the same manner as the telephone programmable buttons.

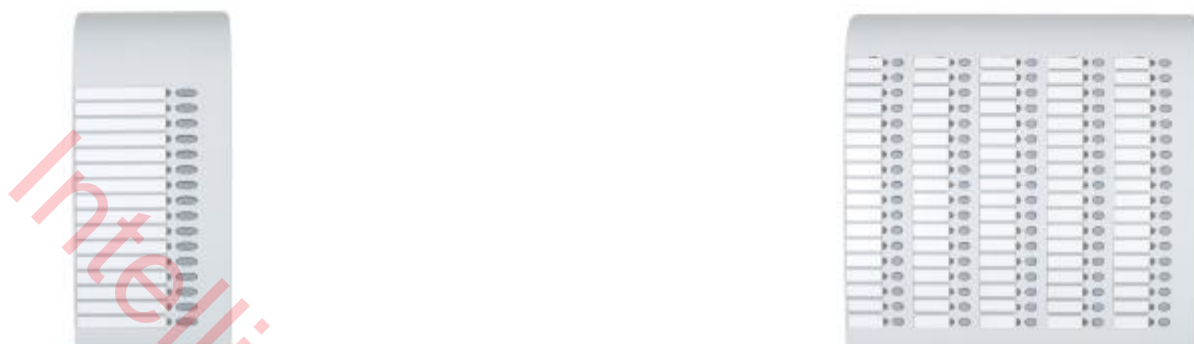
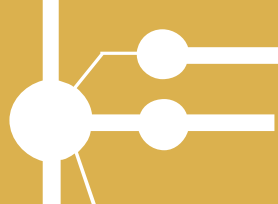

Assistant console (KEY module): Operator console (BLF module)

**Connecting the button console to the telephone** (see the figure below):

Attach the console to the telephone set.

Use the connecting cable to connect the telephone with the console



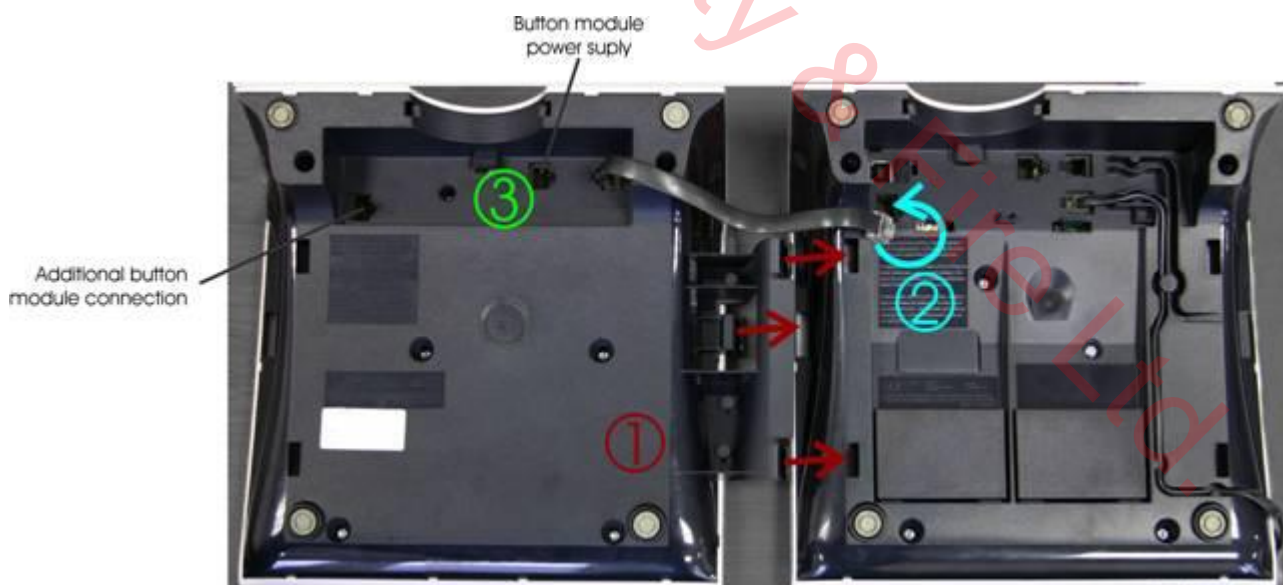

Connect the console power supply cord to the dedicated outlet (on the bottom side) (operator console – BLF module only) using the network adapter included in the supply.





## 1.4 Telephone Description



You can browse the telephone menus and the telephone lists using the “Forward”  and “Back”  buttons. The select button  is used to select the specific function. The “+”  and “-”  buttons are used to change the volume of the call (receiver or loudspeaker). Any change of the volume remains effective during the call; the next call will have the volume set in the telephone menu (or in the environment of the *PbX Configuration tool*).

	Types of 2N StarPoint 500 telephones			
	Entry	Economy	Standard	Advance
Display	–	Two-row	Two-row	Two-row  with backlight
Programmable buttons	8	12	12	19
Hands-free function	One-way	One-way	Two-way	Two-way
Additional modules (KEY, BLF)	–	–	Yes	Yes

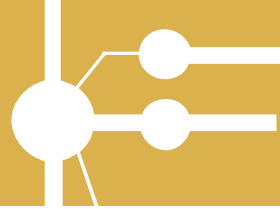

### Telephone display

All 2N StarPoint 500 telephones (except for the Entry model) are equipped with a two-row display. The display contract can be adjusted. For description of the display parameter setup refer to chapter.

Default display status:

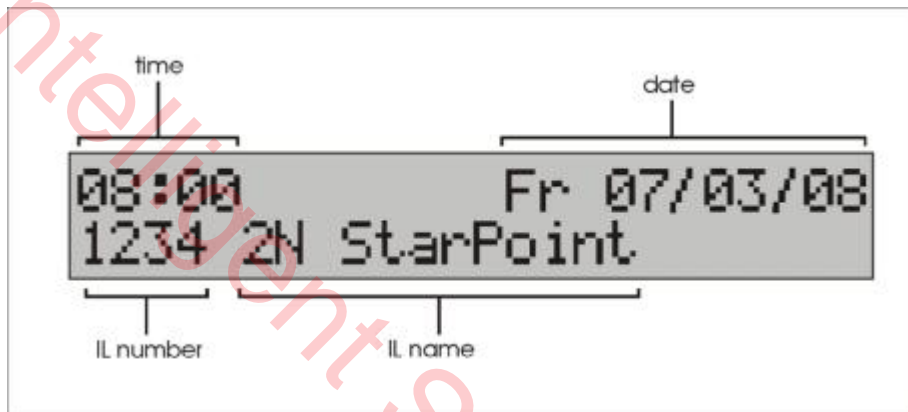

For more comfort when using the 2N StarPoint telephone you may tilt the display.

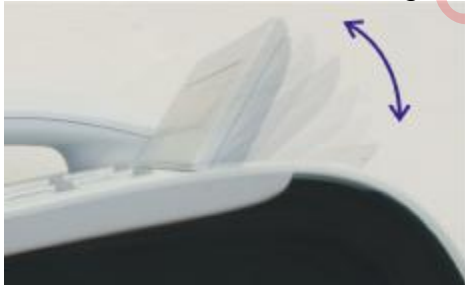

### Programmable buttons

2N StarPoint 500 telephones are equipped with buttons, which are user-programmable in the environment of the *PbX configuration tool*. The basic setup of the programmable buttons is made after the so-called Hardware RESET if the telephone set was connected to the system and also by the system administrator; the user may adjust the button setting according to his/her needs. For more information see chapter *Programmable Buttons Setup*.

Basic available functions of the programmable buttons:

Flash (call interruption for transfer,..)

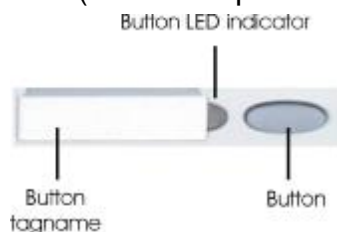

- Transfer (transfer, intercom to assistant)
- Hands-free/one-way hands-free
- Mute (microphone switch-off)
- Redial / List of outgoing calls
- List of personal quick-dial numbers
- List of missed calls
- DND (rejection of a call to the assistant)



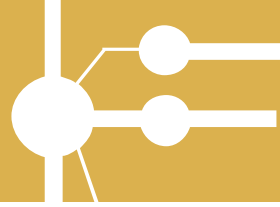

CONF (connecting a call to a conference)  
PARK (parking the call during a call, when idle locking of the telephone set)  
Escape (back in the menu, rejecting a call)

### Overview of calls

Indicators of the buttons set to quick-dialing internal numbers signals the following statuses:

The subscriber is dialing – the indicator is on

The subscriber's telephone is ringing – the indicator flashes quickly

The subscriber is making a call – the indicator is on

Indicator status	Button function	Indicated status
On	Number quick-dialing	The subscriber is speaking
	Hands-free	Hands-free function is active
	Back	The key is active
Flashing	Number quick-dialing	The subscriber's telephone is ringing (quick flashing)
	Microphone off	Microphone off
	Missed calls	You have missed calls

## 2. Basic Operation

### 2.1. Outgoing Calls

Pick up the receiver. You will hear the dialing tone.



Dial Please

Dial a number.

If you have the telephone number stored in your or group telephone book the name of the called party will be displayed on your telephone's display.

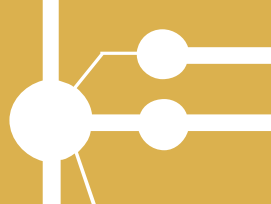

1234 Secretary  
Requested

The time of the call will be displayed when the called party answers the call:

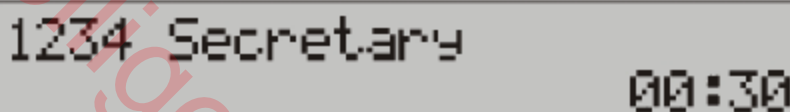

1234 Secretary  
00:30

If the called party is busy you will hear the busy tone and the following message will appear on the display:

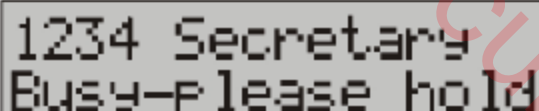

1234 Secretary  
Busy-Please hold

You can also dial the number first, and then start the call by picking up the receiver.

If the called party hangs up during the call, the “caller hung-up” message will appear on your display.



1234 Secretary  
Caller hunged up

To use the hands-free function press the hands-free button  (the switching-on of the hands-free function is signaled by the hands-free button indicator) instead of picking up the receiver. To terminate the call press the hands-free button one more time.

Note: If the hands-free button has not been set on your telephone you can press the select button  to turn on the hands-free function after having dialed the number.

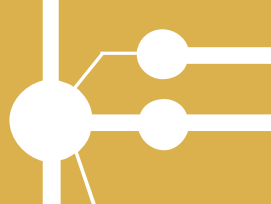

You can set the programmable buttons for so-called one-touch dialing of frequently called numbers. You can then dial the telephone number by pressing a single button. For one-touch dialing setup see chapter *Programmable Buttons Setup*.

The telephone keeps records of missed, incoming and outgoing calls, so-called **list of calls**. Using these lists you can call the parties whom you had already called or who had called you. The lists of calls are accessible through the telephone main menu, by selecting the *List of calls* item. In the lists of calls select the item you wish to call and press the select button (or pick up the receiver) to dial the number. For more information on call history see chapter *List of Calls*.

For simplified calling you may use the **telephone book**, which is accessible by the programmable button . The telephone book allows you to search items by name (or a part of the name); pick up the receiver or press the select button  to dial the selected telephone number.

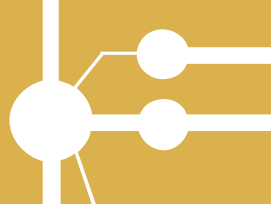



## 2.2. Incoming Calls



Call from  
1234 Secretary

An incoming call is indicated on the telephone display by the caller's name, telephone number. The names are displayed for the numbers according to your personal telephone book, or according to the telephone book assigned by the system administrator.

To answer the call, pick up the receiver or press the select button  (or the hands-free button) – if you want to make the call in the hands-free mode.

To turn down the ringing volume use the “+”  and “-“  buttons.

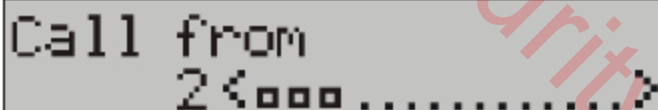

Call from  
2<000.....>

To **reject the call** use one of the following programmable function buttons:



- TRF transfer the call to a defined assistant
- DND transfer the call to an operator
- CANCEL reject the call

## 2.3. During the Call

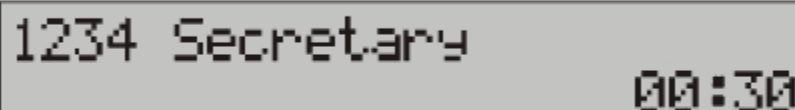
The call duration is displayed during the call.



1234 Secretary  
00:30



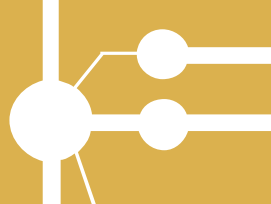

To **change the volume** of the call use the “+”  and “-“  buttons.



Press the hands-free button  to switch to the hands-free mode (the hands-free button indicator lights up); turn the hands-free mode by pressing the button one more time.

To turn off the microphone temporarily during a call (if you do not want the caller to hear you) press the MUTE function button . The button indicator will light up to indicate that the microphone is switched off.

### 2.4. Main Menu

You can enter the main menu of the telephone by pressing the “forward” button  or the “back” button . Use the arrow keys to browse the menu items; enter the individual sub-menus by pressing the select button . To return quickly to the higher level of the menu set the “Back” programmable button .

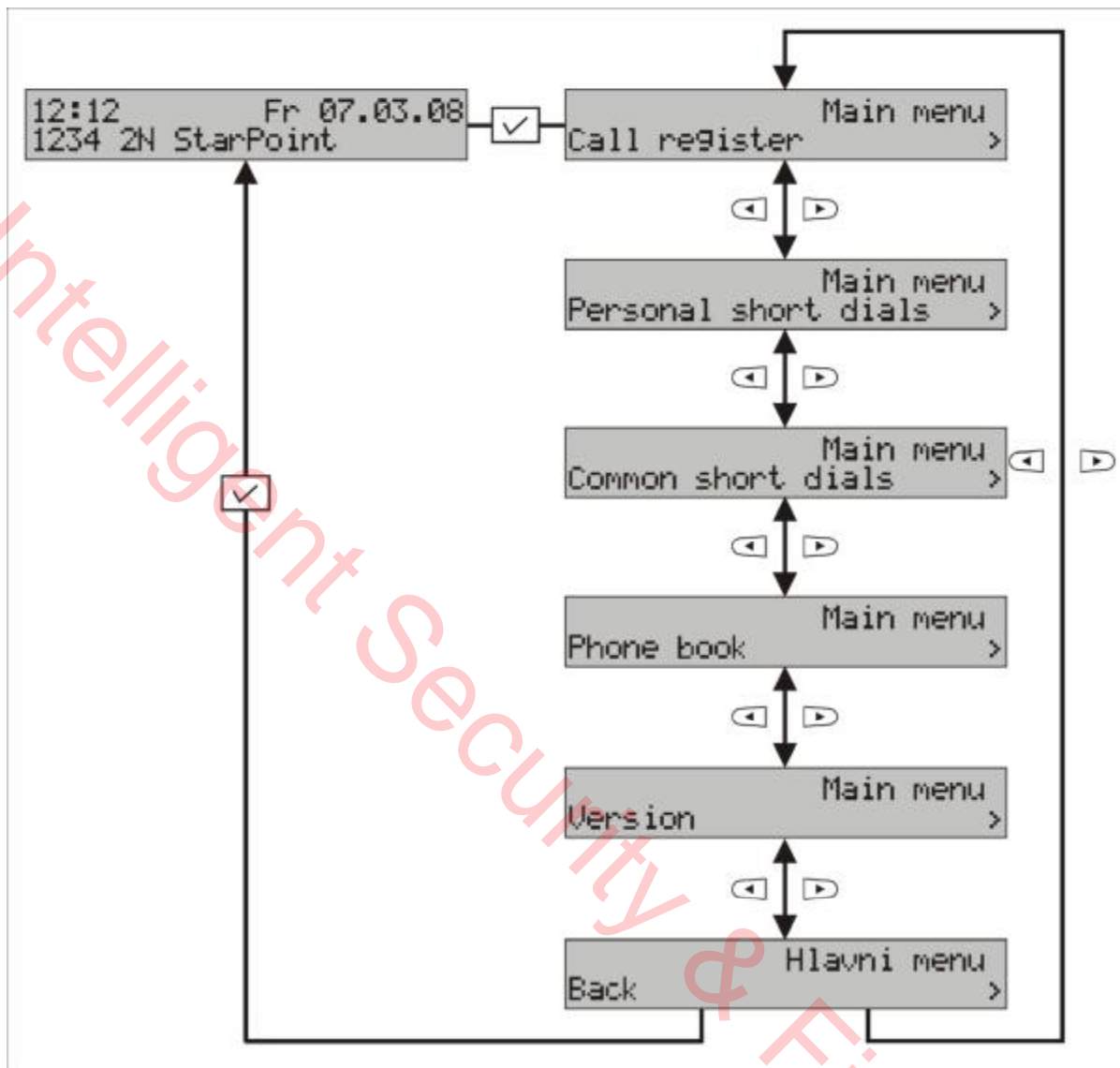
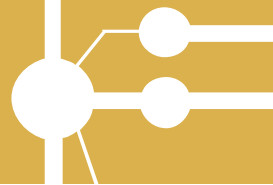

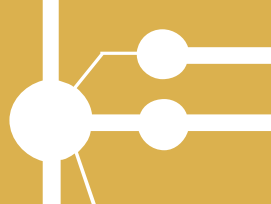

### 3. I would like to...

This chapter provides instructions how to solve standard situations.

#### 3.1. Set the Programmable Buttons

The programmable buttons on your telephone can be set up by the PbX configuration tool. Your system administrator will perform the setup.

After you log in select the system telephone/buttons item in the menu and from the list displayed select the station whose buttons you wish to set. Click the respective button on the telephone picture to display the screen for button setup.

You can assign one of the following functions to the button:

- **Flash** – a short-time disconnection; used for example for transferring calls.
  - **Transfer** – at idle = intercom to the assistant, at ringing = transfer of ringing to the assistant, during the call after FLASH and dialing to finish the transfer.
  - **Handsfree/Speakerphone** – hands-free mode.
  - **Mute** – temporary microphone switch-off during the call.
  - **DND** – at idle = immediate redirecting/cancellation of redirecting to operator (signaled by lit button indicator), at ringing = transfer of ringing to operator.
  - **PARK** – putting a call on hold (allows you to make another call and then return to the call on hold by pressing the button again) (signaled by lit button indicator).
  - **CONF** – function for adding a call to a conference.
  - **Redial** – list of last-dialed numbers.
  - **List of incoming calls** – access to the history of incoming calls.
  - **List of missed calls** – access to the history of missed calls.
  - **Telephone book** – access to the telephone book (PBX line).
  - **Dialing a set number** – one-touch dialing; the set number is dialed by pressing the button. Occupation of the specific internal line is signaled by lighting of the button.
  - **Access to external port** – press the button to occupy and directly go to a specific outgoing line; occupation of the line is signaled by lighting of the button.
  - **Log in department 1-8** – long in/out the internal PBX line departments.
  - **New messages** – direct access to VoiceMail.
  - **ME on/off** – an option to permit/ban calling the MobilityExtension function
  - **Back (Escape)** – rejecting a call, return to a higher level of the menu, deleting telephone book characters.
- + it is possible to add under a programmable button services that can be normally dialed on the telephone keypad (for the list of services see the User Manuals “Basic Services” and “Services for Operator”)



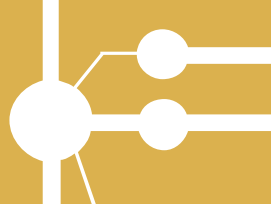

For detailed description of the programmable button functions see chapter *Programmable Buttons Setup*.



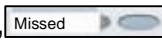

### 3.2. Respond to Missed Calls

**Situation:** the telephone signals missed calls, you want to respond to these calls

**What to do:** If you have defined the button for accessing missed calls,  press this button to access the list.

Otherwise use the “forward” button  to access the main menu, use the select button  to select the *List of call* item; in the list of calls use the “forward” button  and the select button  to select the *List of missed calls*.

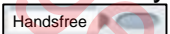

Now the list of missed calls is displayed. Use the “Forward”  and “Back”  buttons to browse the list items.

To select the item you wish to call pick up the receiver or press the hands-free button. 

For more information on list of calls see chapter *Lists of Calls*.

### 3.3. Dial a Previously Called Number

To dial a previously called number use the list of outgoing calls. The telephone set keeps records of the last twenty calls.

**What to do:** From the default status of the telephone use the “forward” button  to access the list of calls; use the “forward” button  and the select button  to select the *numbers called* item.

Use the “Forward”  and “Back”  buttons to browse the list items.

To dial the number pick up the receiver or press the hands-free button. 

### 3.4. Dial a Previously Calling Number

**What to do:** Enter the main menu, select the *List of calls* item, then select *Received calls*. Select the record you wish to call from the list of received calls. Pick up the receiver or press the hands-free button.  For quick access to the list of received calls you can set up a programmable button, see chapter *Programmable Buttons Setup*.

### 3.5. Reject an Incoming Call

**Situation:** Your telephone is ringing, you want to reject the call

**What to do:** 1) Press the **Escape** button  – The caller will hear a busy tone; the call will be recorded in the list of received calls.

2) Press the **TRF** button – The caller will be immediately redirected to your “assistant”.







3) Press the **DND** button - The caller will be immediately redirected to the “operator”.

### 3.6. Turn Down the Ringing Volume

**Situation:** Your telephone is ringing, you don't want to be disturbed by the ringing and you don't want to answer the call

**What to do:** Press and use the “+”  and “-“  buttons.

The sound of the ringing is muted, the caller still hears the ringing tone. You can still answer the call by picking up the receiver.

### 3.7. Turn Off the Microphone Temporarily – To Prevent the Other Party from Hearing Me

**Situation:** During a call you want to prevent the caller from hearing you temporarily

**What to do:** Press the programmable button with the set Mute function  to turn the microphone off temporarily.

### 3.8. Transfer a Call

**Situation:** During a call you want to transfer the caller to another telephone number

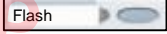
**What to do:** Press the **FLASH** programmable button , you will hear a dialing tone in the receiver (the other hears the on-hold music in the receiver). Dial the telephone number, to which you wish to transfer the call. After getting the ringing tone press the **TRF** function button and hang up. Alternatively, you can wait until the call is answered by the called party (if you want to speak with the party, to which the call is being transferred, before the transfer), press the TRF function button, and after you hang up the parties will be connected.

### 3.9. Add a Call to a Conference

**Situation:** During a call you want to add a third party to a conference.

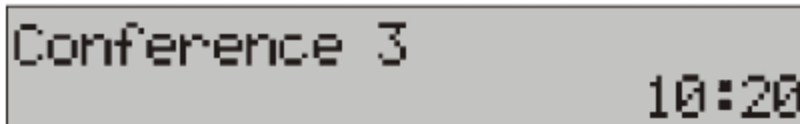

Conference 3 10:20

**What to do:** Press the **FLASH** programmable button , you will hear a



dialing tone in the receiver (the other hears the on-hold music in the receiver). Dial the telephone number of the party you wish to add to the conference. After the called party answers the call press the **CONF** function button. All three parties are now connected. The conference call is indicated on the display by a message "Conference" with the number of lines participating in the conference.

## 4. Telephone Functions

### 4.1. Lists of Calls

The menu of the 2N StarPoint 500 digital system telephones offers lists of missed, received and outgoing calls. The telephone set keeps records of the last twenty calls in each list. You can access the list of calls from the main menu and also by pressing a single button using the programmable buttons.

#### Signaling of missed calls

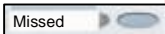
Setting a button to access the call history is convenient especially for the list of missed calls  – after setting up the button, missed calls will be signaled by the button indicator.

Structure of the system telephone menu:

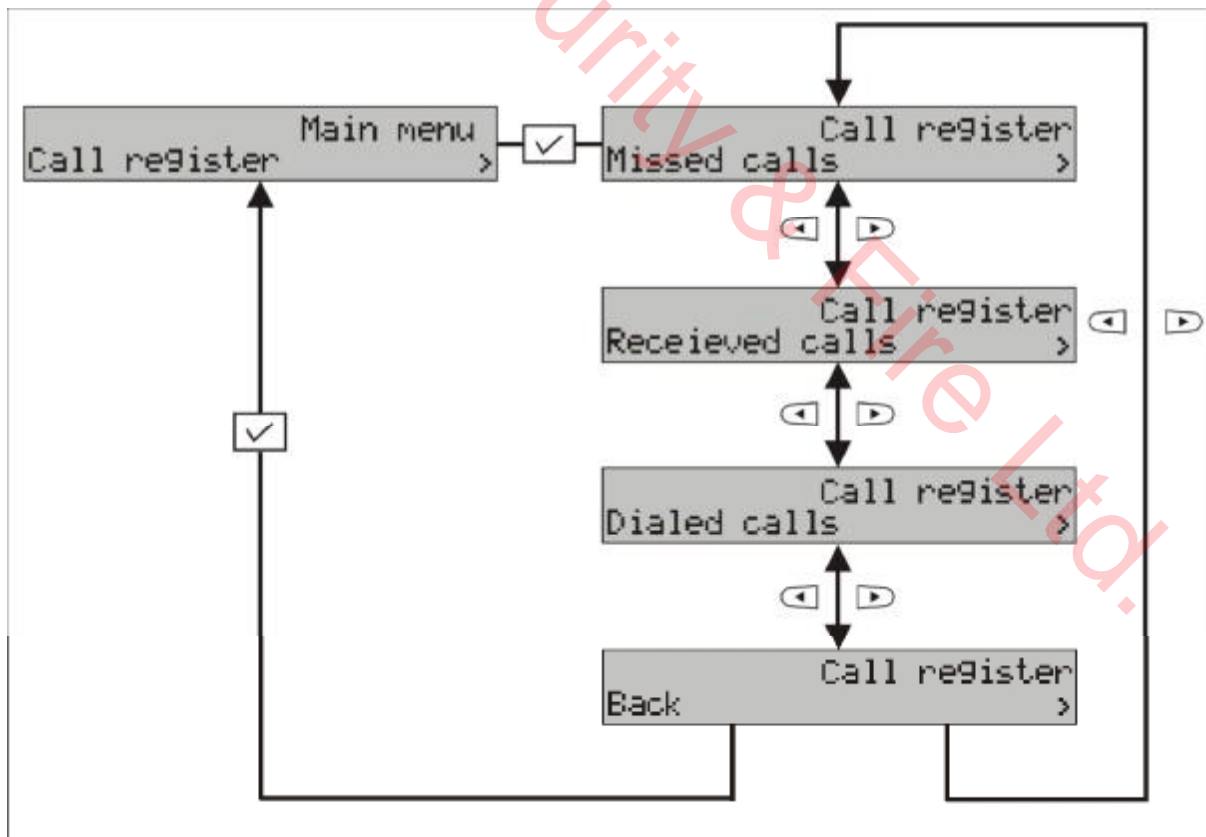

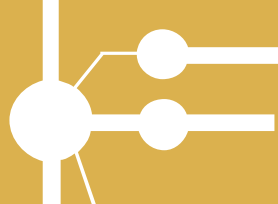

The list of the individual items will be displayed when you enter the respective list of calls.

On the system telephone display:

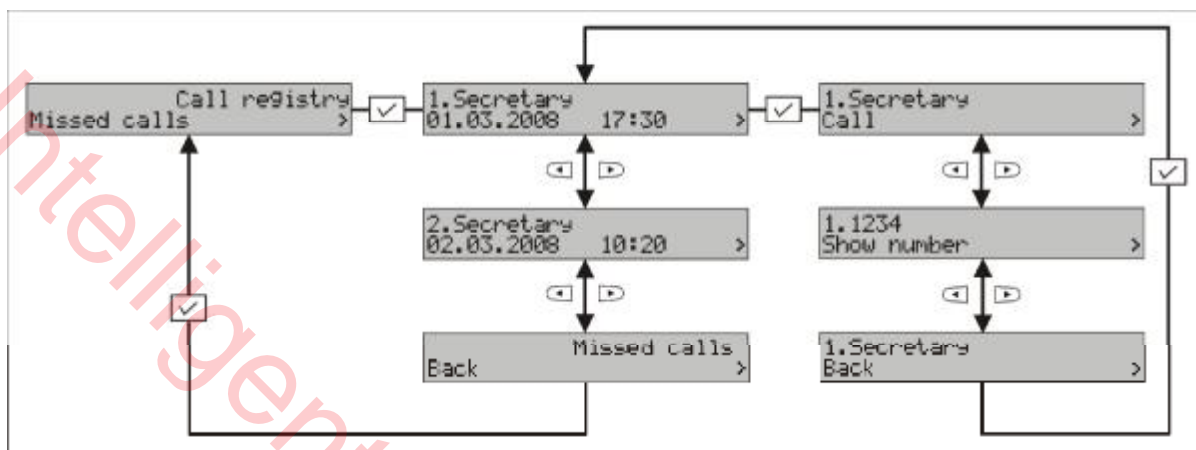

Use the “Forward” and “Back” buttons to browse the individual items. Press the select button to display another sub-menu allowing you to call the respective item.

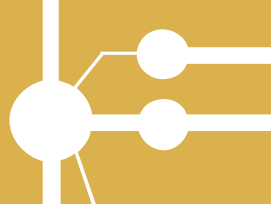

## 4.2. List of Missed Calls

The list of missed calls offers an overview of the last twenty incoming calls that were not answered.

If you have a programmable button set for access to the list of missed calls the indicator of this button signals the missed calls, if any, by flashing.

Missed calls signaling is active until you enter the history of missed calls.

## 4.3. List of Incoming Calls



Displays the list of the last twenty received calls.

## 4.4. List of Outgoing Calls

Displays the list of the last twenty outgoing calls.

## 4.5. Internal Telephone Book

It is a list of all internal PbX lines. With the 2N StarPoint digital system telephone you can search this telephone book and simply call the items selected. To access the telephone book from the system telephone it is necessary to have a programmable button set up; see chapter *Programmable Buttons Setup*.

After pressing the button for access to the telephone book the telephone display will show the search line, the second line shows the individual items of the telephone book. Use the "Forward"  and "Back"  buttons to browse the individual items.



#### 4.6. PBX Services

PBX services can be inserted and dialed using a programmable button, but also directly from the MENU of the digital system telephone, 2N StarPoint 500.

Press the button  for entering the MENU the item   browsing buttons to enter the MENU *PBX functions*.

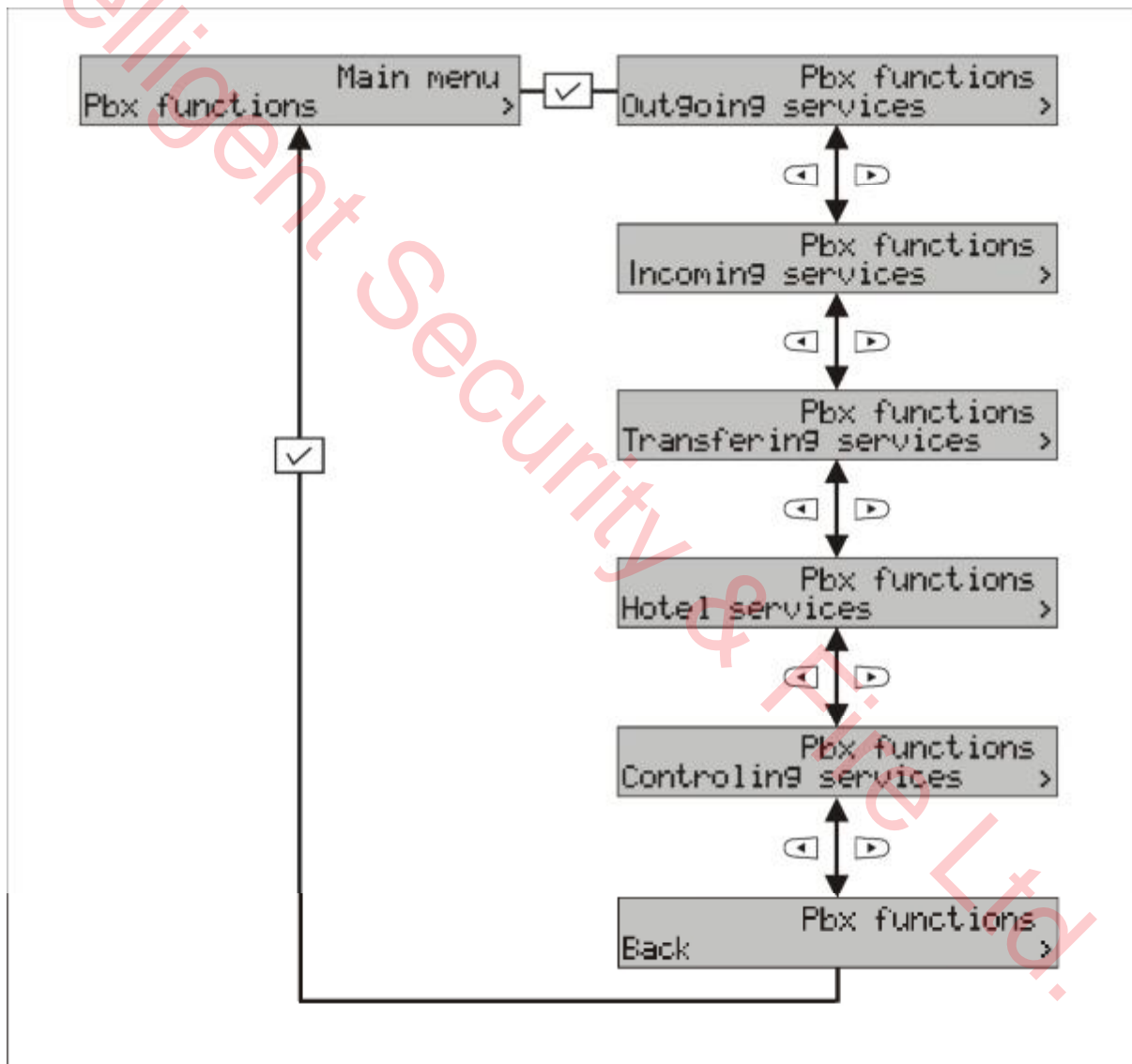

The services are divided, according to the type, into 5 categories. Select the required category, e.g., *Hotel services*.

Here you can select for example *Alarm clock setup for (another line)*.

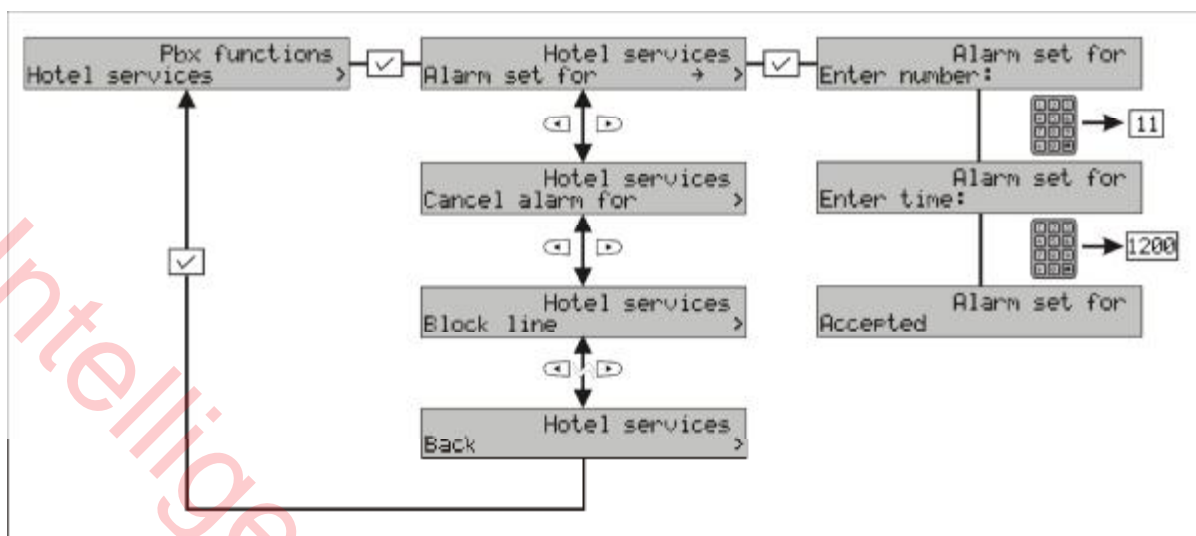
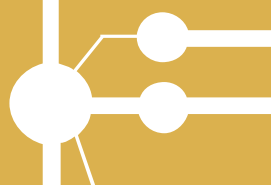

Note:

The use of the different services is described in the manual called *Basic services and Services for the operator*.

### 4.7. Intercom - TRF

Intercom TRF is a special type of call where a preset telephone number, “assistant”, is dialed by pressing the TRF intercom button, and the number called will automatically receive the call in the hands-free mode. This function is suitable for flexible communication – you can speak almost immediately after pressing the button. The intercom - TRF function can be automatically used only between system telephone sets; if the intercom - TRF function is set with a telephone number with another type of telephone set the call will not be automatically accepted.

**Application:** For example, you want to give quickly some information to a colleague equipped with the system telephone: Press the button set for the intercom – TRF function; you can speak after the beep.

The called party answers the call and switches to the hands-free mode; the called party is notified by a sound signal prior to the call. The connection terminates by hanging up.

### 4.8. Displaying the System Version

Digital system telephone supports displaying of the current FW version used in the digital modules attached to your telephone set and also in your PbX (useful for maintenance).

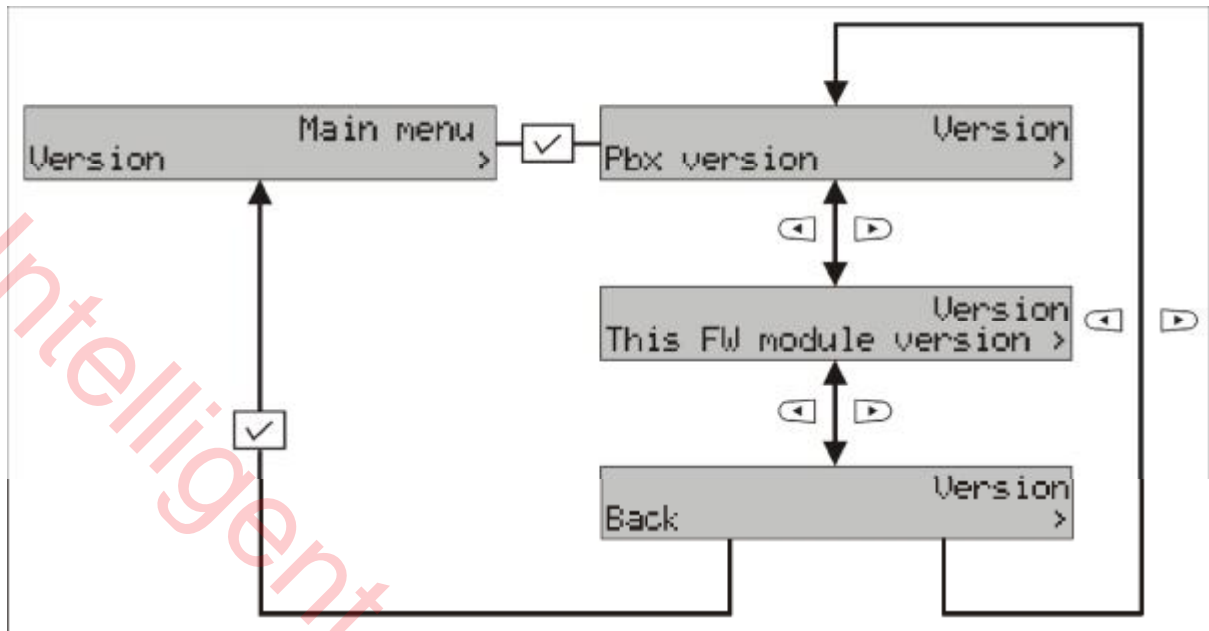
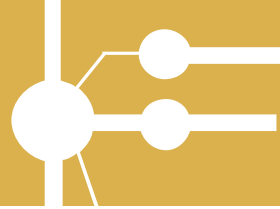

Intelligent Security & Fire Ltd.

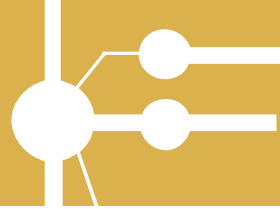

## 5. Telephone Setup

All telephone settings are conveniently accessible in the environment of *Pbx configuration tool*.

### 5.1. Programmable Buttons Setup

Programmable buttons are set up in the environment of *Pbx configuration tool/system lines/buttons*.

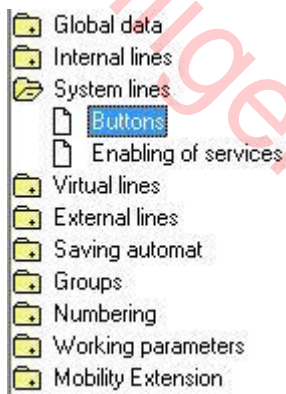



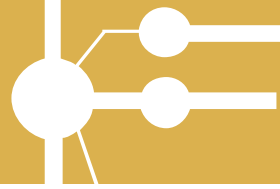



If you want to assign a function (Hands-free, Transfer, Mute,..), direct dialing of an internal line, or direct access to an external line to one of the programmable buttons, first left-click the programmable button you wish to set up as follows:

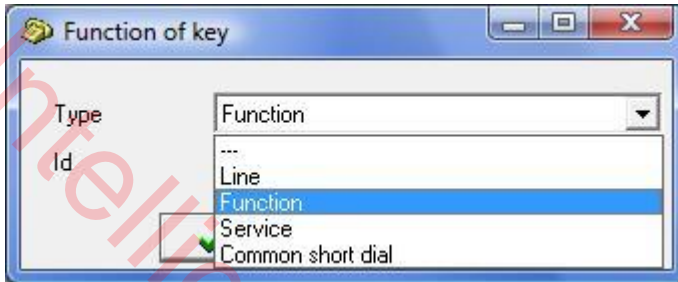

Select the *Type*:

- Line (direct access to internal and external lines)

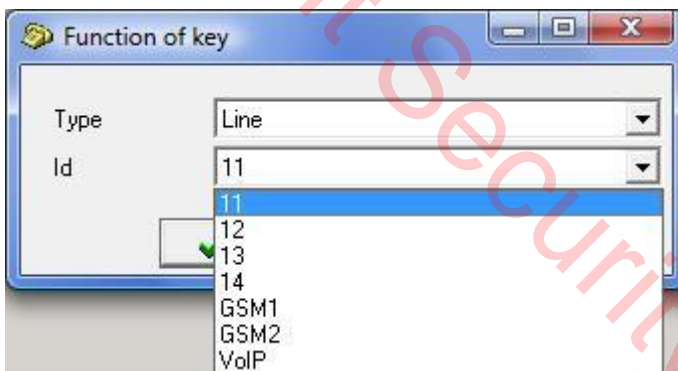

- Function (basic functions for controlling the system telephone – HF, MUTE, TRF, CANCEL,..)

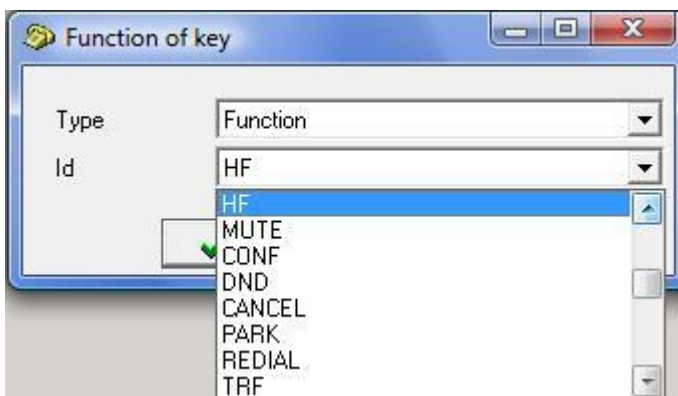

- Service (services – e.g., DAY/NIGHT switching, log in a department, permitting Mobility Extension,..)

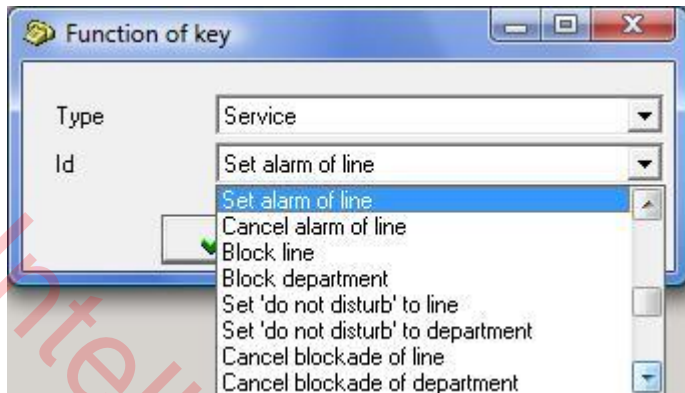

This way you can set up all the programmable buttons you want.

The following will be displayed when right-clicking the mouse button:

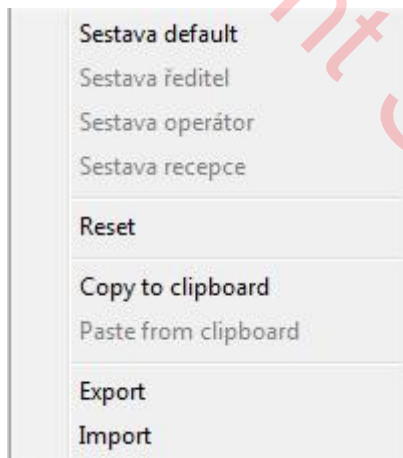

- **Default set**, default settings of the programmable buttons (balanced settings with respect to the individual telephone set types).
- **Manager set**, specific settings of the programmable buttons if at least one extender is connected.
- **Operator set**, specific settings of the programmable buttons if at least one extender is connected.
- **Reception set**, specific settings of the programmable buttons if at least one extender is connected.
- **Reset**, cancels the settings of the programmable buttons.
- **To clipboard**, copies the settings of the programmable buttons.
- **From clipboard**, inserts the copied the settings of the programmable buttons.
- **Export**, exports the settings of the programmable buttons to a “.csv” file.
- **Import**, imports the settings of the programmable buttons from a “.csv” file.

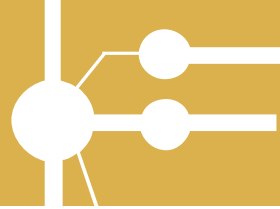

## 5.2. Description of the buttons

All of the descriptions of the buttons can be formed and then printed out in the environment *PbX configuration tool /system lines /buttons/prints*. After filling in the functions of the individual buttons in *MENU PbX configuration tool /system lines /buttons/buttons* the descriptions are reset, but in *PbX configuration tool /system lines /buttons/prints* it is possible to edit them. The number of letters in a text for individual buttons is given by the width of the individual letters used.



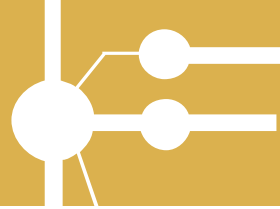

For a “print preview” of the descriptions allow the printing of the individual groups of buttons and press “preview”.

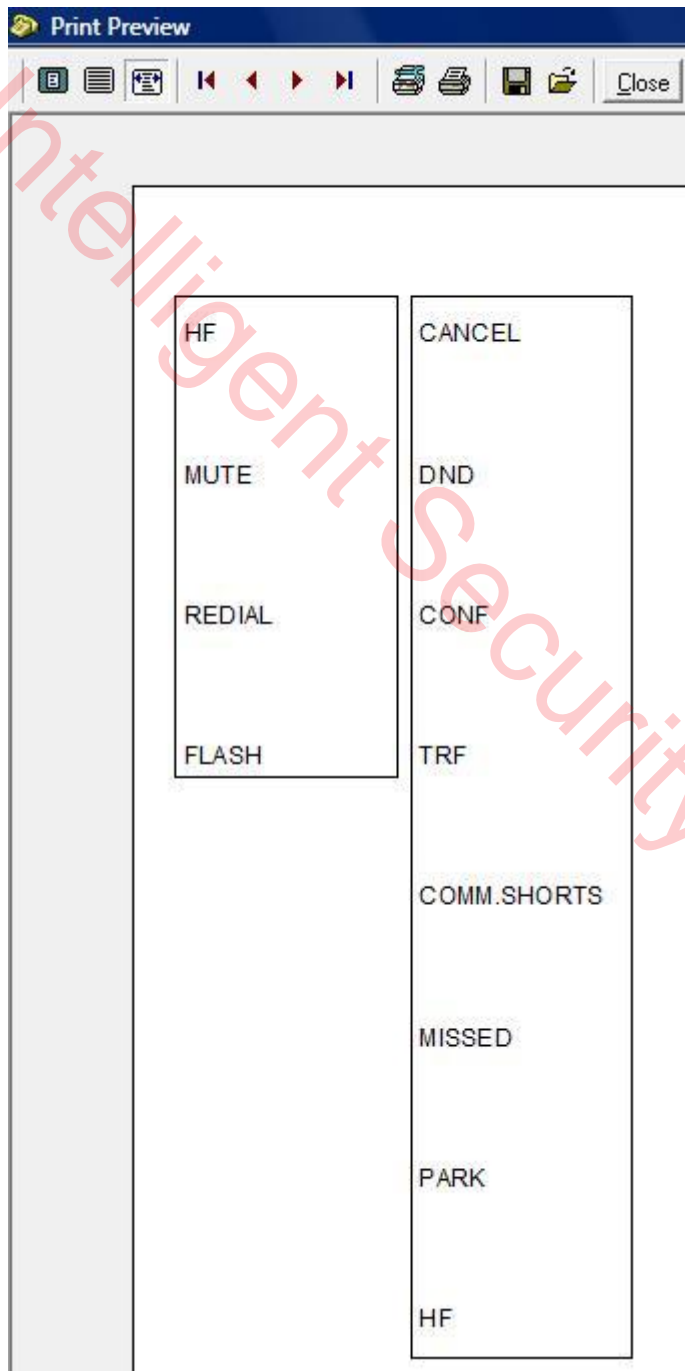

To “Print” the descriptions allow the printing of the individual groups of buttons and press “Print”.

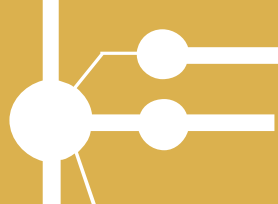

### Volume and Ringtones Setup

2N StarPoint telephones offer the option to select from several ringtones.

Assign the ringtones to the individual types of calls in the environment of *PbX Configuration tool/system lines/buttons/user settings*.

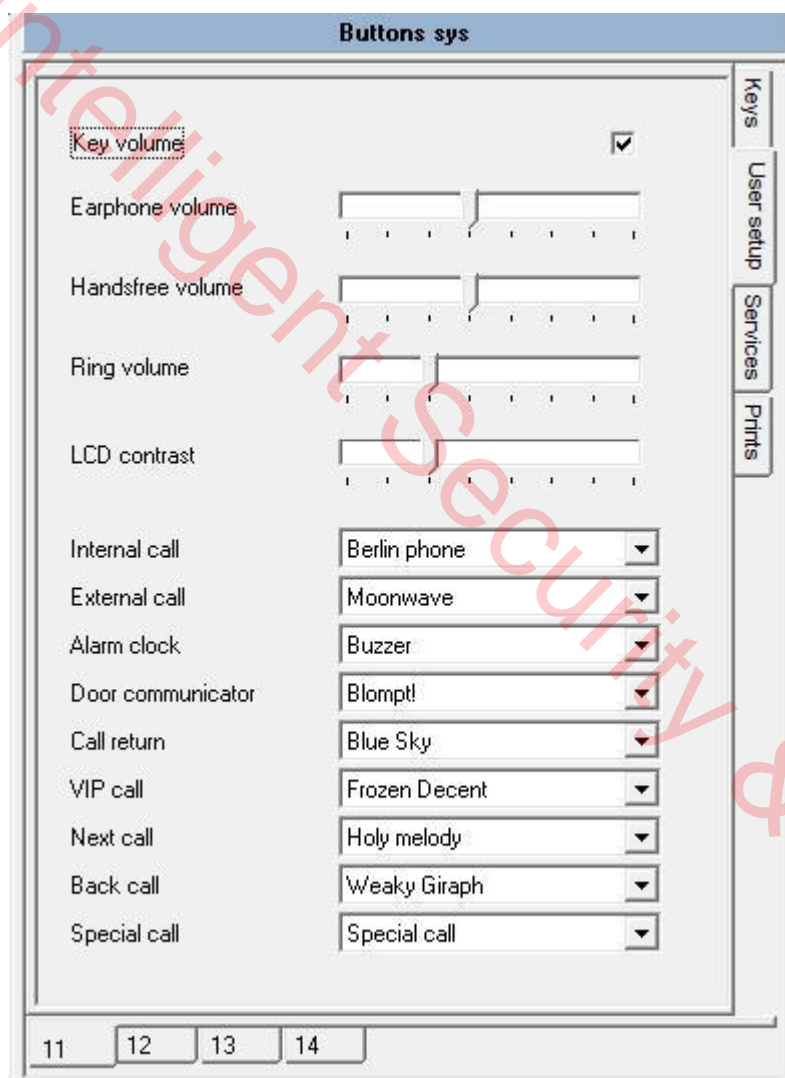

Set:

- Key sound volume**, permitting acoustic signaling of pressing the system telephone buttons.
- Receiver volume**, volume in the receiver.
- Hands-free volume**, volume when using hands-free.
- Ringing volume**, volume of the ringing.
- Display contrast**, display contrast intensity.
  
- Internal calls**, type of ringing when an internal line calls.

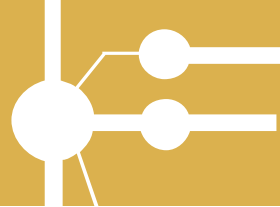

- External calls**, type of ringing when an external line calls.
- Alarm clock**, type of ringing if “alarm clock”.
- Door control/communication system**, type of ringing of the door communicator, “door control/communication system”.
- Call return**, type of ringing if a transferred call comes back.
- VIP calls**, type of ringing if a call comes from the number found in personal quick-dial list of the respective system telephone.
- Back calling**, type of ringing if a call comes from the line that was previously blocking the call using the “waiting for release” service.
- Special calls**,

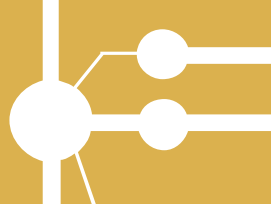

## 6. Important Notices

- The telephone is not to be operated in an explosive environment.
- The telephone is to be connected only to the dedicated outlets.
- The telephone may not come in contact with aggressive substances, fluids that might cause tinting (coffee, tea, wine, etc.). Never use gasoline, thinners, detergents containing alcohol, etc. to clean the telephone set.
- Use a damp cloth or a diluted kitchen detergent to clean the telephone set. Use microfiber cloths to clean the display.

### Compliance Statement



These telephone sets comply with technical requirements for radio and telecommunication equipment pursuant to Act 22/1997 Sb. (Collection of Laws), as amended, and Government Decree No. 426/2000 Sb. (Collection of Laws), and Compliance Statement was issue for them.

### CE Marking



Telephone set compliance with EU directive 1999/5/EG is certified by the CE marking.

### Environmental Marking



This telephone set was manufactured according to ISO 14001 certified environmental system. This process guarantees minimum consumption of the primary raw materials and energy as well as minimum waste.

*The manufacture reserves the right to modify the product relative to the documentation presented, in order to improve the product characteristics.*

**Use the product in accordance with the instructions and for the purposes, for which it has been designed and manufactured.**

**Upon expiry of the service life of the product or a part thereof dispose of these items in compliance with applicable environmental regulations.**