

Ex-3000 Series



Installation and User Manual for Ex-3020 & Ex-3030 Remote Status Indicator Panels

The operation and functions described in the manual are available from Software Versions Ex3030_V2_00 onwards.

Item	Specification Details			
	<i>Ex-3020</i>	<i>Ex-3021</i>	<i>Ex-3030</i>	<i>Ex-3031</i>
Enclosure	Steel IP30			
Dimensions H x W x D mm	190 x 235 x 45			
Environmental Class	Class A – Indoor IP30 0°C to 40°C			
Humidity	95 % Max			
Weight (excluding batteries)	1.5Kg			
Cable Entries (20mm knockouts)	4x top and 4x bottom rear			
Power Supply	24V DC Nominal (18V – 28V DC); 35mA max (backlight on ¹), 20mA max (backlight off ¹).			
Relay Outputs (Optional)	2x rated at 1A 30VAC/DC (max) 10mA 5V (min) programmable (requires EXP-007)			
Key-Switches 1x programmable	Optional	Fitted	Optional	Fitted
Manual Release	No	No	Yes	Yes
External Inputs (Monitored)	2x Programmable			
Communications	RS485 to EX-3000 Series Control Panel			
Display	Graphic LCD 124x64 dots			
LED Indicators	12			
As our policy is one of constant product improvement the right is therefore reserved to modify product specifications without prior notice				

¹ Backlight state is dictated by control panel – refer to control panel installation manual.
Page 2 of 18

Table of Contents

1	INTRODUCTION	4
1.1	Standards	4
1.2	Cautions and Warnings	4
1.3	Description	4
2	OPERATION	5
2.1	Introduction	5
2.1.1	<i>Front Panel Controls and Indications</i>	5
2.1.1.1	Display	5
2.1.1.2	LED Indications	6
2.1.1.3	Manual Release Button (Ex-3030 Only)	6
2.1.1.4	Navigation Buttons	7
2.1.1.5	Key-Switches	7
2.1.1.6	Buzzer	7
2.2	Operating Conditions	8
2.2.1	<i>Fire Alarm Condition</i>	8
2.2.2	<i>Release / Activated Condition</i>	8
2.2.3	<i>Hold Condition</i>	9
2.2.4	<i>Abort Condition</i>	10
2.2.5	<i>Fault Condition</i>	10
2.2.6	<i>Warning Condition</i>	10
2.3	Level 1 Menu Functions	11
2.3.1	<i>Navigating through Level 1 Menus</i>	11
2.3.2	<i>View</i>	11
2.3.2.1	Faults	11
2.3.2.2	Disables	12
2.3.2.3	Warnings	12
2.3.2.4	Software Versions	12
2.3.3	<i>LED Test</i>	12
2.3.4	<i>Exit</i>	12
3	INSTALLATION	13
3.1	Installation Approvals	13
3.1.1	<i>Fire System Installations</i>	13
3.1.2	<i>Wiring Regulations</i>	13
3.2	Identification of Parts	13
3.3	Installing the back box	14
3.4	Wiring Installation	15
3.4.1.1	24V DC Power	15
3.4.1.2	Relay Outputs	15
3.4.1.3	RS485 Communications	16
3.4.1.4	Input Circuits	16
3.4.1.5	USB	16
3.5	Key-Switch Installation	17
3.6	Adjusting the LCD Contrast / Address setting	17

1 Introduction

1.1 Standards

The *Ex-3000* Series of Gas Extinguishing Remote Status Indicating Panels conform to the following standards:

BS EN60950: 2000 Safety of information technology equipment

BS EN50130-4: 1996 Product Family Standard

Electromagnetic Compatibility Directive 89/336/EEC (and the amending directive 92/23/EEC)

Low Voltage Directive 73/23/EEC

1.2 Cautions and Warnings



Only Trained service personnel should undertake the Installation, Programming and Maintenance of this equipment.

1.3 Description

This manual covers the installation and use of the *Ex-3000* Series Remote Status Indicating Panels.

The *Ex-3020* is an RSI with Liquid Crystal Display and LED Indicators.

The *Ex-3021* is an RSI with Liquid Crystal Display, LED Indicators and Mode Select Key Switch.

The *Ex-3030* is an RSI with Liquid Crystal Display, LED Indicators and Manual Release Button.

The *Ex-3031* is an RSI with Liquid Crystal Display, LED Indicators, Manual Release Button and Mode Select Key Switch.

A Key-Switch can optionally be fitted to the *Ex-3020* and *Ex-3030*.

Each RSI has built-in circuits for connection of two external input devices.

Each RSI has the option for two additional programmable relay outputs (requires additional module).

All programming and configuration (except device address) is performed at the *Ex-3001* Extinguishing Control Panel.

2 Operation

2.1 Introduction

These instructions cover the operation and use of the panels.

2.1.1 Front Panel Controls and Indications

Ex-3030

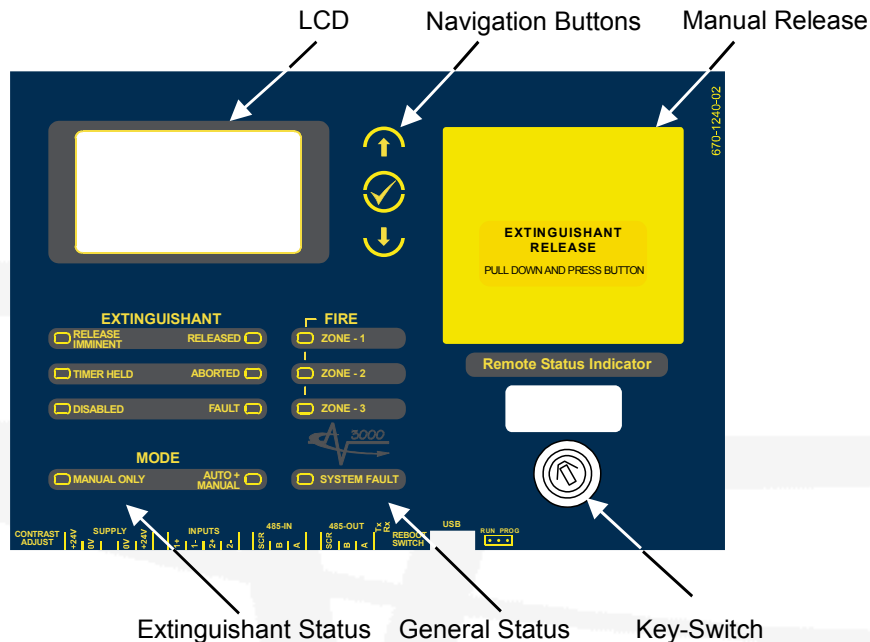

Ex-3020

The Ex-3020 has an identical arrangement to the Ex-3030 but is without the Manual Release function.

2.1.1.1 Display

The LCD along with the LED Indicators shows the operating status of the system. Examples of the information presented is shown below:

Normal Display

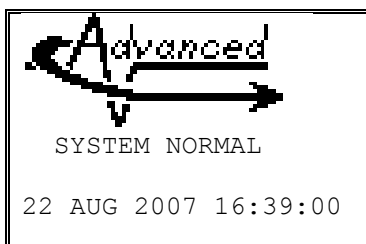

Non-normal Display

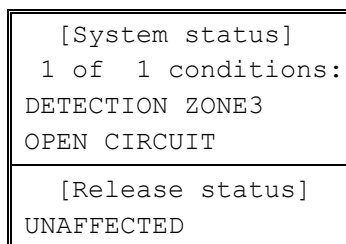

Menu Display

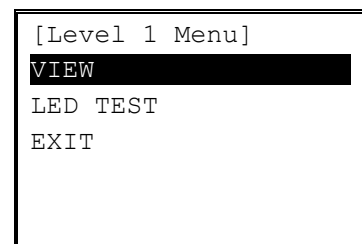

Release Imminent

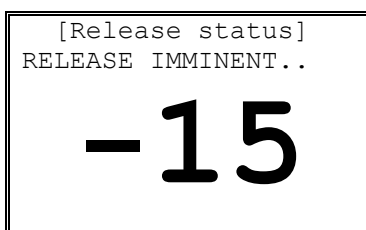

The display shows a countdown timer with the amount of time remaining before the extinguishant is released.

Release Activated

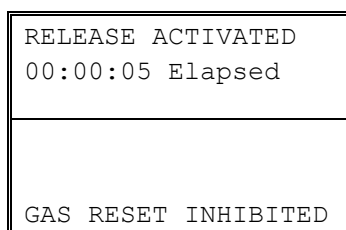

The display shows the time elapsed since the extinguishant release commenced.

Release Complete

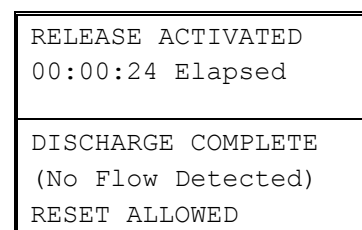

2.1.1.2 LED Indications

The LED Status Indications show the basic operational state of the panel and whether the panel is in a fire alarm, fault, disabled or test condition.

2.1.1.2.1 GENERAL STATUS

Function	Colour	Description
SYSTEM FAULT	Yellow	Indicates the presence of a system fault

2.1.1.2.2 DETECTION ZONE STATUS

Function	Colour	Description
FIRE	Red	Indicates that the system has detected a fire alarm condition in the respective zone

2.1.1.2.3 EXTINGUISHANT



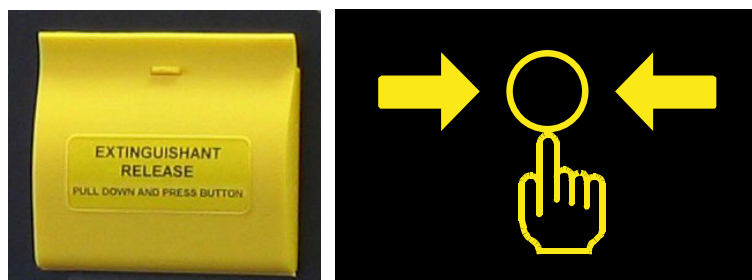

Function	Colour	Description
RELEASE IMMINENT	Red	Indicates (flashing) that the release of extinguishant is imminent. The indication will turn to steady when the signal to release the extinguishant has been activated.
RELEASED	Red	Indicates that the release of extinguishant has occurred and the panel has detected the flow of the extinguishant released.
TIMER HELD	Yellow	Indicates that the imminent release of extinguishant is temporarily suspended.
ABORTED	Yellow	Indicates that the imminent release of the extinguishant has been aborted.
DISABLED	Yellow	Indicates that the extinguishant release control signal has been disabled. The release of extinguishant is prevented even if a fire alarm or manual release are present.
FAULT	Yellow	Indicates that the system has detected a fault condition within part of the extinguishing system and control device (ECD) circuits.
MANUAL ONLY	Yellow	Indicates that the extinguishant can only be released by means of a manual release button.
AUTO + MANUAL	Yellow	Indicates that the extinguishant can be released by both the automatic detection of a fire alarm and by means of a manual release button.

2.1.1.3 Manual Release Button (Ex-3030 Only)

To manually release the extinguishant, pull down the flap and press the button marked with the circle.



2.1.1.4 Navigation Buttons

	 	<p>Press to scroll through the list of event conditions.</p> <p>Press to scroll through menu options.</p>
		<p>Press to display the menu and confirm selection of a menu option.</p> <p>Press to exit from a menu option.</p> <p>Press to MUTE panel buzzer (if configured).</p>

2.1.1.5 Key-Switches



One key-switch is fitted to the panel.

The functions of these are programmable and the installer will have inserted a label to indicate their use.

Typical uses are:

AUTO + MANUAL / MANUAL ONLY Selection

EXTRACT OVERRIDE

Depending on the key-switch mechanism fitted, the key may be removable in only one position or removable in both operating positions.

2.1.1.6 Buzzer

The buzzer produces two different sounds to differentiate between fire alarm conditions and fault / warning conditions.

Condition	Operation
Fire Alarm	The buzzer operates with a continuous tone.
Fault	The buzzer operates intermittently.

2.2 Operating Conditions

2.2.1 Fire Alarm Condition

<pre>[Fire Detected] FIRE STARTED: ZONE 1 TOTAL FIRES: 1</pre>
<pre>[Release Status] STAGE-1</pre>

The display shows location / origin of the fire alarm and the total number of zones in a fire alarm condition.

If two or more zones enter the fire alarm condition, the display also shows the location of the last zone to enter a fire alarm condition.

In addition, the General Fire LED and the respective Zone Fire LED will be illuminated.

<pre>[Fire Detected] FIRE STARTED: ZONE 1 LAST FIRE : ZONE 3 TOTAL FIRES : 2</pre>
<pre>[Release Status] STAGE-1</pre>

The status of the extinguishant release is also indicated. If a fire alarm occurs in a zone that has no effect on the extinguishant control then the display shows UNAFFECTED.

The fire alarm bells / sounders will activate (depending on how they are programmed to respond).

To silence the internal buzzer, press the ✓ button (if configured) or the MUTE button on the control panel.

To silence the bells, press the SILENCE button on the control panel.

To reset the panel, press the RESET button on the control panel.

NOTE: If the programming of the panel is such that the release condition is immediately invoked on detection of a single fire alarm, then the display will immediately show the release status information.

2.2.2 Release / Activated Condition

The activated condition is established when one or more fire alarms have occurred or when the manual release button is pressed.

The number of zones, and which zones, that must be in a fire alarm condition before the activated condition is invoked depends on the installation programming of the panel.

<pre>[Release status] RELEASE IMMINENT..</pre> <p style="font-size: 2em; text-align: center;">-15</p>

When the activated condition is established, the display indicates that the release is imminent and also shows a countdown timer with the number of seconds remaining before the extinguishant is released.

In addition, the Release Imminent LED flashes.

If programmed, the bells / sounders will ring with pulsed alert tone.

<pre>RELEASE ACTIVATED 00:00:05 Elapsed</pre>

When the countdown timer has elapsed, the actuating output is activated to start the release of the extinguishant.

The display now shows the time elapsed since the release of extinguishant commenced.

In addition, the Release Imminent LED turns ON steady.

RELEASE ACTIVATED 00:00:10 Elapsed
DISCHARGE COMPLETE (No Flow Detected)

When the discharge is complete (either time elapsed or flow detected) the display indicates the discharge is complete.

RELEASE ACTIVATED 00:00:10 Elapsed
RELEASE CONFIRMED DISCHARGE COMPLETE

If confirmed by the detection of the flow of the extinguishant, the display shows RELEASE CONFIRMED (Released Condition) and the RELEASED LED turns ON steady.

If previously silenced, the internal buzzer will re-sound. Press the ✓ button to silence the buzzer.

RELEASE ACTIVATED 00:00:20 Elapsed
DISCHARGE COMPLETE EXTRACT RUNNING RESET ALLOWED

When the extinguishant has been fully released and if automatically or manually activated, the output to control the extract fan will be turned on.

This is indicated on the display as EXTRACT RUNNING

When the discharge is complete, the display prompts that the panel can be reset – reset must be performed at the control panel.

To reset the panel, press the RESET button on the control panel.

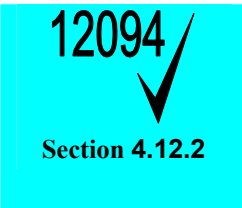

Reset of the Activated Condition / Release Signal.

NOTE: In accordance with EN 12094-1, the ECD shall not permit a reset until either the RELEASED condition has been established (flow detected) or until after a programmable time following activation of the mechanism to release the extinguishant.

NOTE: Depending on programming, the EXTRACT condition may persist after the panel is reset for up to 120 minutes. This will be indicated on the normal status display (Extract Running).

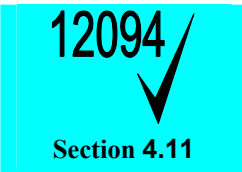

Released Condition.

NOTE: In accordance with EN 12094-1, the activated / release condition may be established without the detection of a fire alarm or manual release. If the panel detects the release of extinguishant, it will immediately indicate the released condition.

2.2.3 Hold Condition

COUNTDOWN ON HOLD (Remove HOLD resume)
-15

If any hold button is activated, the imminent release countdown is held for as long as the button is pressed.

The display shows the HOLD condition and the TIMER HELD LED is illuminated.

When the hold button is release, the panel will resume the imminent release countdown either from the time remaining or from the maximum time programmed.

2.2.4 Abort Condition

RELEASE ABORTED! PRESS RESET TO REARM
--

If an abort button is activated, the imminent release countdown is aborted.

The display prompts for the panel to be reset and the ABORTED LED is illuminated.

Ensure that the abort button is de-activated and then press the RESET button.

2.2.5 Fault Condition

[System status] 1 of 1 conditions: DETECTION_ZONE3 OPEN_CIRCUIT
[Release status] UNAFFECTED

If the control panel detects a fault condition, the display will indicate the number and nature of the faults. The internal buzzer will sound with an intermittent tone and the FAULT LED indication will be illuminated.

Press the **↑↓** buttons to scroll through the list of faults.

Press the **✓** button to silence the internal buzzer (if configured).

NOTE: The fault condition is non-latching (except System Fault) and the indications will automatically be cleared when the fault is remedied. Press the RESET key to clear a System Fault.

NOTE: If silenced, the buzzer will re-sound when a new fault occurs.

[System status] 1 of 1 conditions: DETECTION_ZONE3 OPEN_CIRCUIT
For service call: 01234 567 890

When the system buzzers are muted, the bottom two lines of the display will show the telephone number to call for service (if programmed) for four seconds.

2.2.6 Warning Condition

[System status] 1 of 1 conditions: PRESSURE_MONITOR OPEN_CIRCUIT
[Release status] UNAFFECTED

If the panel detects an extinguishant warning condition, the display will indicate the number and nature of the warnings. The internal buzzer will sound with an intermittent tone and the FAULT LED indication will be illuminated.

Press the **↑↓** buttons to scroll through the list of faults.

Press the **✓** button to silence the internal buzzer.

2.3 Level 1 Menu Functions

The following table gives a list of the Level 1 Menu Functions and a brief description for each function.

Menu Option	Sub Menu / Item	Comments / Description
VIEW	FAULTS	View any current fault conditions recorded.
	DISABLES	View any current disablement conditions.
	WARNINGS	View any current extinguishant warnings conditions.
	LOG	View the history log.
	SW VERSIONS	View the software version installed in the extinguishant control panel and in remote status indicator panels.
LED TEST	--	Disable Zone, Sounder, Input and Output circuits and disable functions. Enable any current disablement conditions
EXIT	--	Return to the normal status display.

2.3.1 Navigating through Level 1 Menus

[Level 1 Menu]
VIEW
LED TEST
EXIT

Press the ✓ button to select the Menu Options

When the menu is displayed, use the ↑↓ buttons to highlight the required menu option and then press the ✓ button to select it.

Press the ✓ button from within a menu option to return to the previous menu.

The display will revert to the status mode display after 60 seconds on no activity (15 seconds in a fire alarm condition). Press the ✓ button again to return to the menu option.

2.3.2 View

On selection, the current status of any Faults, Disablements and Warnings along with the history Log can be shown.

[View Menu]
FAULTS
DISABLES
WARNINGS
SW VERSIONS
EXIT

Press the ↑↓ buttons to scroll through the list and press the ✓ button to select the required view option.

[Fault Status]
Nothing to Report

If there are no conditions present, the display will show "Nothing to Report".

2.3.2.1 Faults

[Fault Status]
1 of 3
DETECTION ZONE 1
>SHORT CIRCUIT
DETECTION ZONE 2
>OPEN CIRCUIT

If there are fault conditions present, the display will show the number of conditions and a list of the fault conditions.

Press the ↑↓ buttons to scroll through the list of faults.

Press the ✓ button to return to the previous menu.

2.3.2.2 Disables

```
[Disable List]
Zone 1      DISABLED
Man Release DISABLED
```

If there are disablement conditions present, the display will show the number of conditions and a list of the disablements.

Press the **↑↓** buttons to scroll through the list of disablements.

Press the **✓** button to return to the previous menu.

Disable conditions can only be set on the control panel.

2.3.2.3 Warnings

```
[Warning Status]
      1 of 2
VALVE MONITOR INPUT
>VALVE CLOSED
PRESSURE MONITOR
>LOW PRESSURE
```

If there are warning conditions in the extinguishant system present, the display will show the number of conditions and a list of the warning conditions.

Press the **↑↓** buttons to scroll through the list of warnings.

Press the **✓** button to return to the previous menu.

2.3.2.4 Software Versions

The display shows the revision of software installed in this RSI. The software revisions of the control panel and all RSI units can be viewed simultaneously on the panel.

```
[Software Versions]
RSI-6 : 02.00
```

On selection, the display shows a list containing the panel and any configured remote status indicators along with the version of software installed in each device.

Press the **↑↓** buttons to scroll through the list of entries.

Press the **✓** button to return to the previous menu.

2.3.3 LED Test

On selection, the front panel LED Indicators will be illuminated for a short period of time.

2.3.4 Exit

On selection, the display reverts to the normal status display indications.

3 Installation

3.1 Installation Approvals

3.1.1 Fire System Installations

The panel must be installed and configured for operation in accordance with these instructions and the applicable code of practice or national standard regulations for fire systems / extinguishing system installation (for example BS5839-1: 2002, BS7273-1: 2006) appropriate to the country and location of the installation.

3.1.2 Wiring Regulations

The panel and system must be installed in accordance with these instructions and the applicable wiring codes and regulations (for example BS7671) appropriate to the country and location of the installation.

3.2 Identification of Parts

The following diagram shows the major parts of the panel.

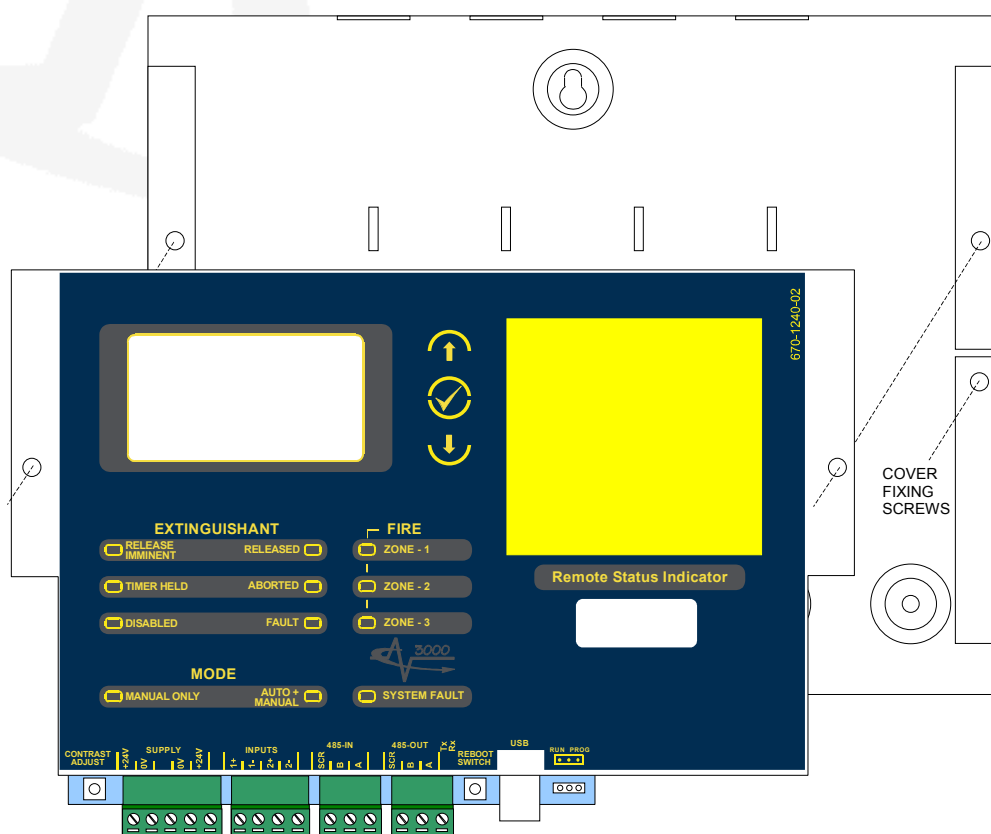

The panel comprises a back box and cover, chassis assembly.

The chassis is mounted onto the back box via two screws and keyhole mounting holes. The screws do not have to be removed to remove the chassis.

The chassis contains the main printed circuit card with terminal block connections for field wiring. A fascia label is affixed to the front of the chassis providing the user controls and indications (LCD and LED indicators). A hinged yellow plastic cover is fitted to the front face and provides access to the manual release button (Ex-3030 only).

Standoff pillars are provided in the back box to fit a standard Exp-007 2-Way Relay Module. This is connected to the main printed circuit card via ribbon cable.

One (programmable function) key-switch assembly can be fitted to the chassis plate below the manual release cover. The cables plug onto the main printed circuit card. Slide-in labels with pre-printed text are available.

3.3 *Installing the back box*

Enclosure dimensions and fixing points are shown in the diagram below. Remove the chassis before installing the enclosure (retain in a safe place).

Ensure that there is sufficient space to allow the cover to be removed / opened when the panel is finally mounted.

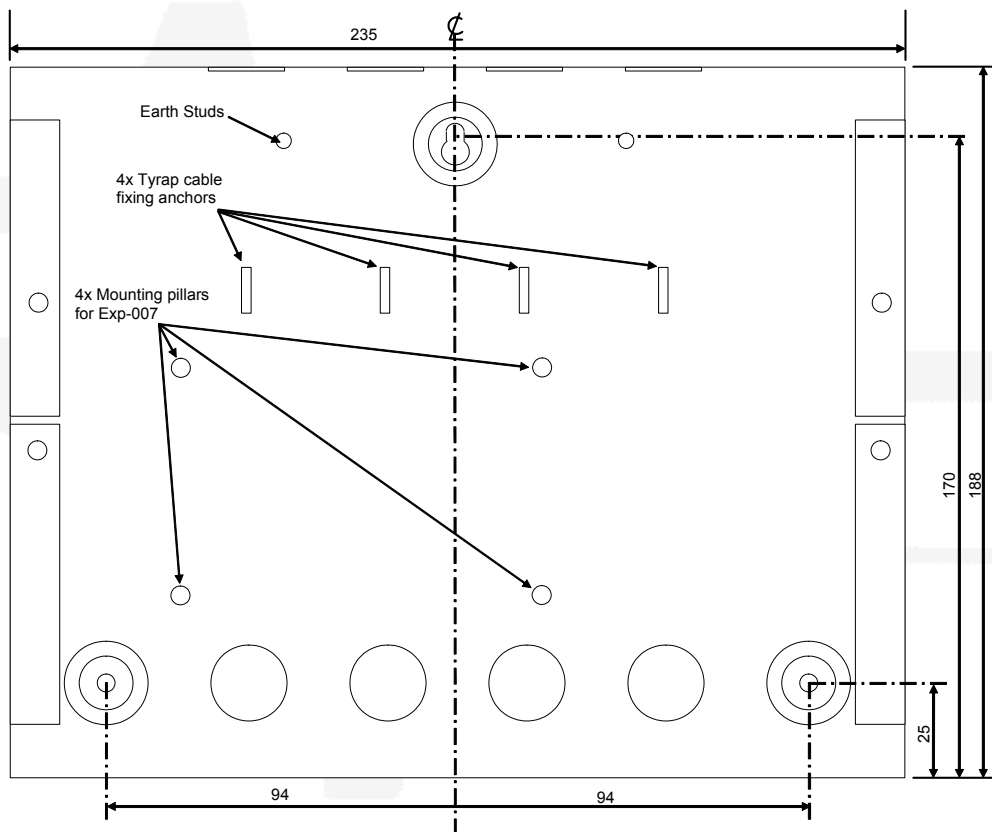

3.4 Wiring Installation

The unit is designed for easy wiring installation. “Plug-in” terminal blocks are provided for all connections to the unit.

NB: Minimum / Maximum cable size for terminal block connections is limited to 0.35mm² - 2.5mm² (22-14AWG).

All electrical wiring installation work should be carried out in accordance with the code of practice applicable in the country of installation.

To maintain electrical integrity of the SELV wiring on the DC Power and Communications lines all SELV wiring should be segregated from LV mains wiring and be wired using cable with insulation suitable for the application.

To minimise the effects of EMC interference all data wiring circuits should be wired with a twisted pair of conductors with a cross sectional area suitable for the loading conditions.

In areas where cabling may come into contact with high frequency interference, such as portable radio transceivers etc. the data wiring cable should be of a twisted pair construction within an overall screen. Care should be taken to correctly terminate this screen, refer to the information below.

3.4.1.1 24V DC Power

A 24V DC power supply is required.

Note: The DC power supply used MUST BE designated a Safety Extra Low Voltage (SELV) supply.

Connect the 24V DC supply feed input to the SUPPLY +24V and 0V terminals on the interface card.

Use cables of sufficient size to ensure that the power input voltage is maintained under all supply conditions – refer to specifications section.

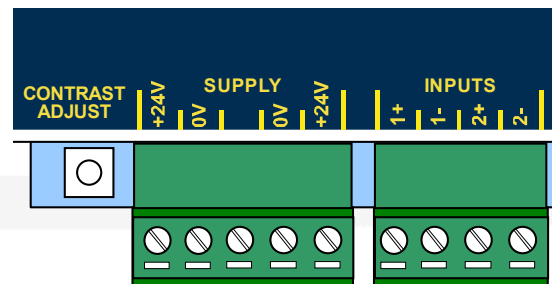

OBSERVE POLARITY OF CONNECTIONS



A secure ground connection is required. Although no system is immune to the effects of lightning strikes, a secure ground connection will reduce susceptibility.

Run an earth cable (or use the drain wire of the DC Power lead) between the unit and the control panel. Fixing points are provided in the back of the enclosures to terminate the earth.

3.4.1.2 Relay Outputs

If additional relays are required, then install the Exp-007 2-Way Relay card in the rear of the enclosure.

Mounting pillars are provided. Affix the card with the supplied M3 fixing screws.

Connect the 4-Way ribbon cable between the relay card and the main chassis card (PL3) – the connectors are polarised to prevent incorrect connection.

Two changeover volt-free relay outputs are provided. Each is rated at 30V AC/DC, 1A, resistive.

Both Relay outputs are programmable (refer to Extinguishing Control Panel manuals).

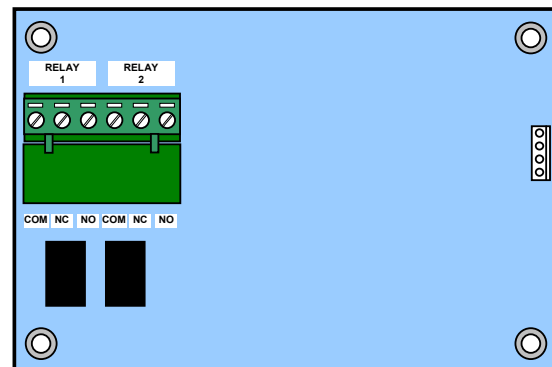

3.4.1.3 RS485 Communications

One RS485 bus circuit is provided for connection of the Remote Status Indicator panels to the Extinguishing Control Panel.

SUPERVISED. POWER LIMITED.

Wiring to be twisted pair. The use of screened cable is recommended in noisy environments.

Maximum distance 1000m. Maximum line impedance 50Ω.

Connect the cable from 'A' to 'A' and from 'B' to 'B'. Equipment is connected via a daisy chain. A 150Ω End-of-Line resistor to be fitted at last unit.

Connect the screen to one of the earth studs in the back of the panel enclosure and to the designated point in the remote status indicator panels. Ensure the screen is continuous.

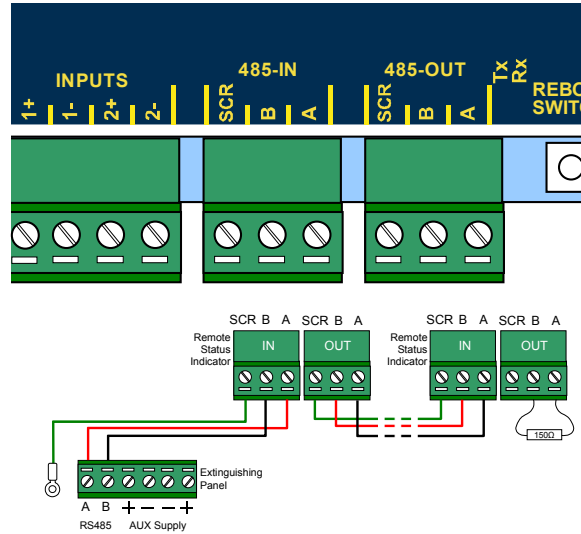

3.4.1.4 Input Circuits

Two Programmable Function Input Circuits are provided.

Each input circuit is monitored for open and short circuit conditions – see typical arrangement below.

EOL = 6800Ω. Maximum line impedance 50Ω.

Connect to volt-free switches / relay contacts only.

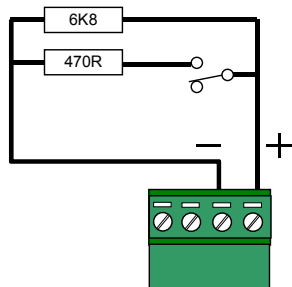

TYPICAL SWITCH ARRANGEMENT

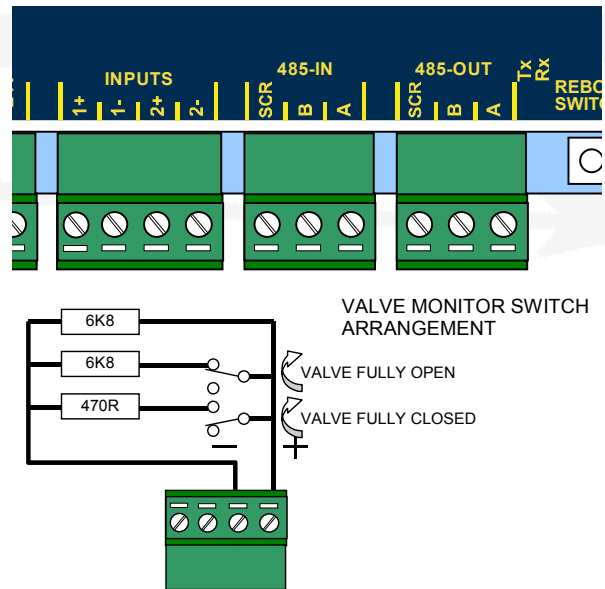

VALVE MONITOR SWITCH ARRANGEMENT

The VALVE MONITOR input is used to monitor the open / closed state of a mechanical valve control device.

If the valve is in an indeterminate state (neither fully open nor fully closed) for more than 30 seconds, the panel will indicate a fault condition.

The function / action of the inputs is defined in the control panel. Refer to the control panel manual for further details. If unused, connect a 3300Ω (or 2x 6800Ω in parallel) EOL across the terminals.

3.4.1.5 USB

The USB socket is for connection to a Laptop or PC.

This can be used for upload of a new logo.

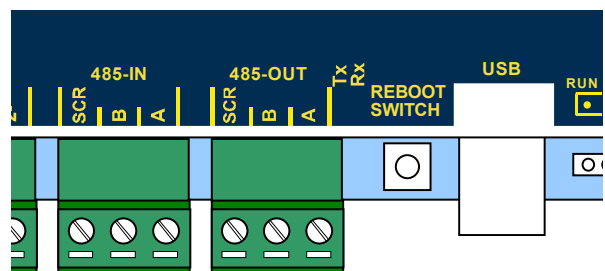

3.5 Key-Switch Installation

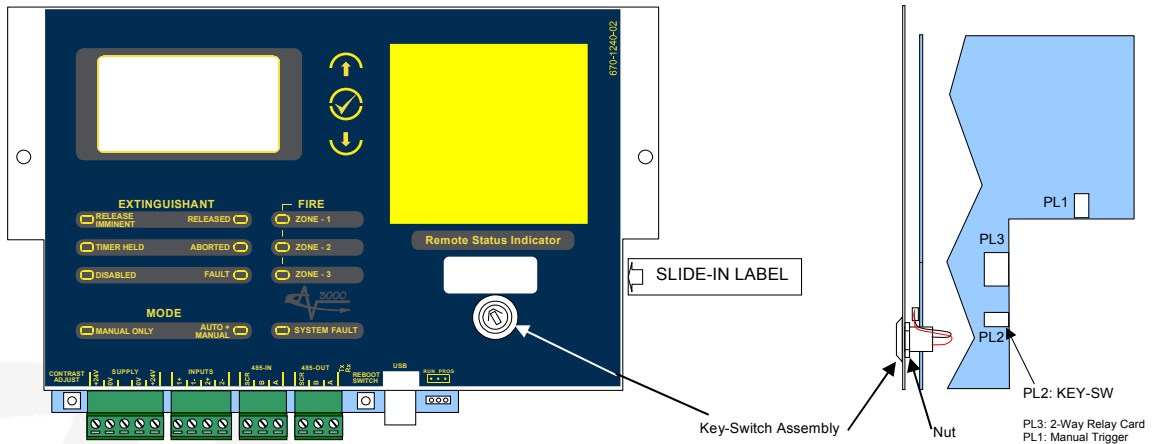

Using a sharp knife, cut through the fascia label using the key-switch mounting hole as a template.

Insert the key-switch assembly through the hole and secure with the fixing nut. Before fully tightening, insert the slide-in label with the required function description into the pocket in the fascia label.

Plug the connector into the respective connector on the card.

Key-Switch assemblies are available in both trapped and non-trapped versions.

The function / action of the key-switch is defined in the control panel. Refer to the control panel manual for further details.

3.6 Adjusting the LCD Contrast / Address setting

Press the CONTRAST ADJUST button. This display will show the contrast adjust option.

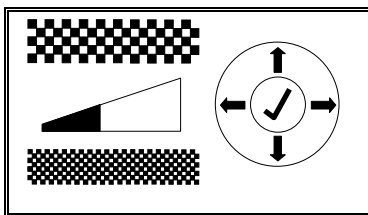

Use the $\uparrow\downarrow$ buttons to adjust the contrast (viewing angle) darker or lighter as required. The bar graph adjusts to show the contrast setting.

Press the \checkmark button to confirm the setting.

The display will then show the unit address.

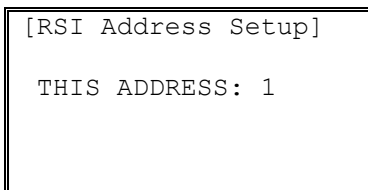

Use the $\uparrow\downarrow$ buttons to adjust the address as required.

Press the \checkmark button to confirm the setting.

The display will then revert to the normal operating display.

This page is intentionally left blank.



Document Number: 680-149 Revision: 03



34 Moorland Way : Nelson Park : Cramlington
Northumberland : NE23 1WE
Tel: +44 (0)1670 707 111
Fax: +44 (0)1670 707 222
www.Advel.co.uk Email: Sales@Advel.co.uk

