

Videoswitch

Vi200 Digital Recorder User Manual



Models covered by this manual

Hard Drive Capacity	4 Cameras	6 Cameras	9 Cameras
80 Gbytes	Vi200-G80-4e	Vi200-G80-6e	Vi200-G80-9e
160 Gbytes	Vi200-G160-4e	Vi200-G160-6e	Vi200-G160-9e
250 Gbytes	Vi200-G250-4e	Vi200-G250-6e	Vi200-G250-9e
300 Gbytes	Vi200-G300-4e	Vi200-G300-6e	Vi200-G300-9e
400 Gbytes	Vi200-G400-4e	Vi200-G400-6e	Vi200-G400-9e
500 Gbytes	Vi200-G500-4e	Vi200-G500-6e	Vi200-G500-9e

Document Reference

Vi602e.doc

Date

30/09/2005

Firmware

From Vi008B09/F

Videoswitch

Telephone 01252-851510

Ocean House, Redfields Industrial Park

Fax 01252-851296

Redfields Lane, Church Crookham

Email sales@videoswitch.co.uk

Hants GU52 0RD

Web www.videoswitch.co.uk

Intelligent Security & Fire



Digital Recorder

Contents:

1	Start Here	1
1.1	Connecting Up	2
1.2	Setting Date/Time	3
1.3	Recording.....	4
1.4	Routine Checks.....	4
1.5	Care of the Hard Drive	4
1.6	Critical Alerts	5
2	LIVE	6
2.1	Viewing Full Screen Images	6
2.2	Quad Display.....	6
2.3	9-way Multi-Screen	7
2.4	Spot Monitor.....	7
3	FIND	8
3.1	FIND-1 Date/Time	8
3.2	FIND-2 Sweep.....	9
3.3	FIND-3 Event List.....	10
3.4	FIND-4 Incidents	11
4	PLAY.....	12
5	BURN.....	13
5.1	BURN-1 Edit Incident.....	13
5.2	BURN-2 Multiple Incidents.....	14
6	PSW	15
6.1	Log-On	15
6.2	Log-Off	16
7	FN.....	17
7.1	Cancel All	17
7.2	Panic Record - Yes	17
7.3	Panic Record - No.....	17
7.4	Disable Alarms - Yes	17
7.5	Disable Alarms - No	17
7.6	Disable Activity - Yes	18
7.7	Disable Activity - No.....	18
7.8	Seq Main - Yes.....	18
7.9	Seq Main - No	18
7.10	Seq Spot - Yes.....	18
7.11	Seq Spot - No.....	18
8	INFO.....	19
8.1	INFO-1 Configuration.....	19
8.2	INFO-2 Status	19
8.3	INFO-3 Drives	19
8.4	INFO-4 Record.....	19
8.5	INFO-5 Play	19
9	MENU.....	20
9.1	Date/Time.....	21
9.1.1	Date/Time	21
9.1.2	Summer/Winter Time	22



Digital Recorder

9.2	Record.....	22
9.2.1	Days.....	22
9.2.2	Cameras.....	23
9.2.3	Quality.....	23
9.2.3.1	Audio Sensitivity.....	23
9.2.4	Timers.....	24
9.2.4.1	Weekday.....	24
9.2.4.2	Weekend.....	24
9.3	Display.....	25
9.3.1	Keypad Brightness.....	25
9.3.2	Auto Seq Dwell - Main.....	25
9.3.3	Auto Seq Dwell - Spot.....	25
9.3.4	Camera Titles.....	25
9.4	Alarms.....	26
9.4.1	Activity Detection.....	26
9.4.2	Relay Hold Time.....	26
9.4.3	Video Loss Alert.....	26
9.4.4	Clear Event List.....	26
9.4.5	Alarm Timers.....	26
9.4.5.1	Weekday.....	26
9.4.5.2	Weekend.....	26
9.4.6	Activity Timers.....	27
9.4.6.1	Weekday.....	27
9.4.6.2	Weekend.....	27
9.5	Network.....	28
9.5.1	IP Address.....	28
9.5.2	Port.....	28
9.5.3	Sub-Net mask.....	28
9.5.4	Gateway.....	28
9.5.5	PSTN Rings.....	28
9.5.6	Dial-up Type.....	28
9.6	Configuration.....	29
9.6.1	Passwords.....	29
9.6.1.1	Logged-Off Access Rights.....	29
9.6.1.2	User 1.....	29
9.6.1.2.1	User 1 Password.....	29
9.6.1.2.2	User 1 Access Rights.....	30
9.6.1.3	User 2.....	30
9.6.1.3.1	User 2 Password.....	30
9.6.1.3.2	User 2 Access Rights.....	30
9.6.1.4	User 3.....	30
9.6.1.4.1	User 3 Password.....	30
9.6.1.4.2	User 3 Access Rights.....	30
9.6.1.5	User 4.....	30
9.6.1.5.1	User 4 Password.....	30
9.6.1.5.2	User 4 Access Rights.....	30
9.6.2	Covert Cameras.....	31
9.6.3	Camera Inputs.....	31
9.6.3.1	Record Brightness.....	31
9.6.3.2	Record Colour Boost.....	31
9.6.4	Record Audio.....	31
9.6.5	Restore Factory Config.....	32



Digital Recorder

9.6.6	Erase Hard Drive	32
9.6.7	Remote Keyboard Monitor	32
9.6.8	Unit Address	33
10	Audio	34
11	Ethernet	35
11.1	Ethernet connection to a PC	35
11.2	Ethernet connection to a LAN network	35
11.3	Ethernet connection to an ADSL router	35
12	Remote Keyboard	36
13	Dial-Up Access	37
13.1	Vi-PSTN	37
13.2	Vi-ISDN and Vi-ISDN/TA	37
13.3	Connecting a Dial-up Adaptor	37
14	Technical Data	38
14.1	Power-On Reset	38
14.2	Accessories Included	38
14.3	Changing the Hard Drive	38
14.4	Connector Pin-Outs	39
14.4.1	Alarms	39
14.4.2	Remote Keyboard	40
14.4.3	PSTN/ISDN Modem	41
14.5	Specifications	42
14.5.1	Storage	42
14.5.2	Digital recording/Replay	42
14.5.3	Display	42
14.5.4	Control and Interface	42
14.5.5	Remote Viewing	43
14.5.6	Power, Physical & Environmental	43
14.5.7	Upgrades	43
14.5.8	CE Marking	44
14.5.9	Ventilation	44
14.5.10	Safety	44
15	Warranty Fax-Back	47

Intelligent Security & Fire



Digital Recorder

Intelligent Security & Fire

1 Start Here

Please fill in the warranty fax-back form on page 47 and return it to Videoswitch

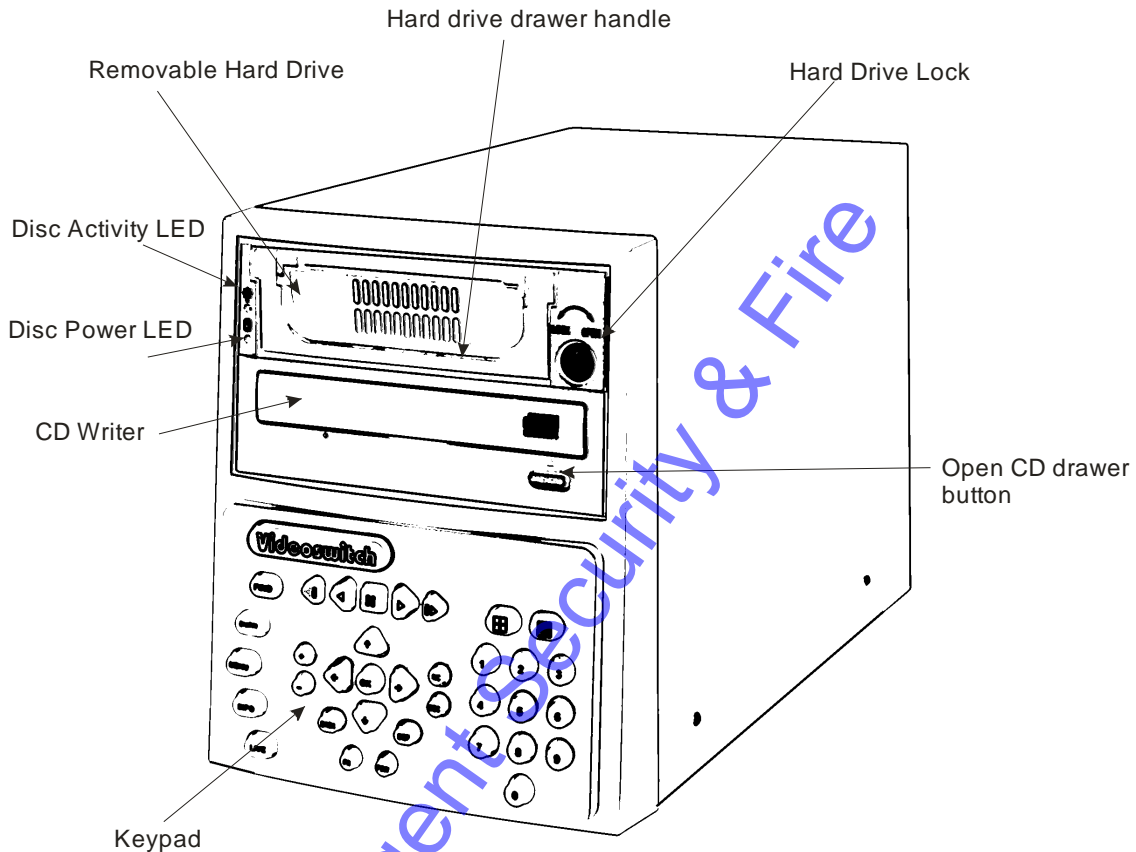

The Vi200 is designed to be easy to use whilst offering high quality digital video recording and playback, primarily for CCTV security applications.

The video images from all connected cameras are continuously recorded onto the built-in hard disc. When the disc is full, the Vi200 keeps on recording, overwriting the oldest images.

Images are retained for a specified user programmable number of days, typically 14 or 31. All images recorded within the period will be available for replay. Older images are no longer available.

Several methods are provided for finding the recorded images you want quickly.

The built-in CD writer allows a selected part of the recorded information to be written onto a CD, typically to back-up an incident for use as evidence by the Police.

The recording process continues all the time, even when playing back or writing to CD.

An optional dial-up module allows images to be viewed on a PC (with a modem) via a telephone line.

1.1 Connecting Up

For a standard digital recording system you will need

- The Vi200 recorder

- Some cameras with lenses

- A video monitor (with BNC composite video input).

- BNC cables

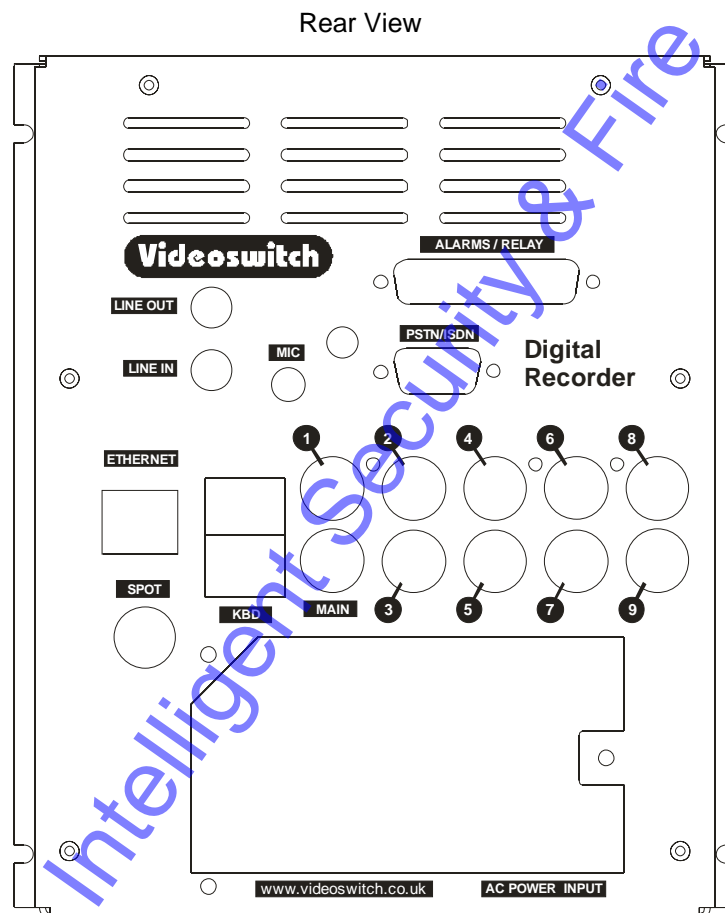

Connect the monitor output (MAIN) of the Vi200 to a Video Monitor using a BNC cable

Make sure that the monitor termination is switched on (i.e. to 75 Ohms)

Connect a camera to Camera Input 1 on the Vi200 using a BNC cable

Connect further cameras to Inputs 2,3,4 etc

Make sure that the voltage select switch is set to suit the mains supply. The setting required in UK and Europe is normally 230Vac.

Connect the mains power using the mains cable provided

1.2 Setting Date/Time

For proper operation of the Vi200 Digital Recorder it is essential that the date and time are set correctly.

If the system clock has an invalid date or time when the Vi200 is powered up (or at any time during operation), the date and time setting window will be automatically displayed

If this occurs, use the number keys to enter the date and time.

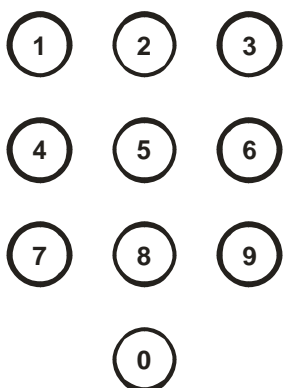

The format for the date and time is **DD/MM/YY HH:MM:SS** where:

- DD is the day of the month (00 to 31),
- MM is the month (01 to 12),
- YY is the year (e.g. 04 for the year 2004),
- HH is the hour in 24-hour format (00 to 23),
- MM is the number of minutes past the hour (00 to 59) and
- SS is the number of seconds past the minute (00 to 59).

The arrow keys may be used to move the cursor to different positions if only some digits need changing:



Press OK to finish:



If you need to adjust the time and date at any other time, refer to section 9.1. Note that the time is automatically adjusted forwards or backwards by an hour at the appropriate dates to take account of British Summertime so no user action is required.

1.3 Recording

The Vi200 Digital Recorder should now be fully operational and recording images from all cameras. The default image retention period is 31 days unless set otherwise in the menu (see section 9.2.1).

1.4 Routine Checks

If the Vi200 is *not* recording, the message **STOP** will be displayed on top right of the video monitor. This should only happen if there is no video, if no hard drive is fitted or if it is faulty, or if record timers have been set to disable recording.

Although the system is intended for continuous un-attended operation, **it is recommended that the user regularly check that images from all cameras replay correctly.** Any potential problems with the cameras or recording system will then be detected as soon as possible, rather than continuing un-noticed until a critical incident needs to be recalled from the system.

Similarly, **when a CD has been created you should check that it plays back correctly,** before the images on the hard drive in the Vi200 become over-written. The CD may be checked by either by playing it on the Vi200 or on a PC.

1.5 Care of the Hard Drive

The hard drive is a delicate mechanical item that should be handled with care. Before moving a Vi200 that has been powered up, remove power and **wait for 30 seconds for the drive to stop spinning.** This is a precaution to avoid possible damage to the hard drive.

1.6 Critical Alerts

The Vi200 constantly monitors the hard drive, camera inputs and system so that detected fault conditions will be reported to the user as soon as possible by means of a “critical alert” message on the screen. Alerts are also added to the event list.

- **FailTest** *This alert indicates that the self-test has failed – try the following*
 - Press the **INFO** key to call up the “**FIND-2 Status**” screen. The positions of any solid blocks displayed on the “Self Test” row indicate various fault conditions.
 - Enter the menu, change any setting and return to LIVE mode so that settings are saved.
 - Switch off the Vi200, wait 10 seconds and switch on again.
 - Try a power-on reset
 - If the problem persists, contact your supplier.
- **HD1 Fail** *This alert indicates that the hard drive is not working.*
 - Check that the drive drawer is correctly fitted
 - Check the lock in the drive drawer is turned full counter-clockwise
 - Check the **DISC ACTIVITY** LED is flickering
 - Check that the red **DISC POWER** led is lit.
- **HD1 SMART** *This alert indicates that the hard drive may stop working soon*
 - The SMART monitoring detects imminent failure of a hard drive, so if this warning occurs, the drive should be changed at the earliest opportunity.

To cancel a critical alert, press the **FIND** key several times until the “**FIND-3 Event**” screen is displayed.



The time of alert will be displayed on the list (see section 3) and the alert will be cancelled.

Note that if the alert condition persists, the alert message will re-appear.

2 LIVE

Press this key to view live images on the main monitor.



This key may be pressed at any time to exit from any other screen.

2.1 Viewing Full Screen Images

Select full screen views of different cameras on the main monitor by pressing the **NUMBER** keys:

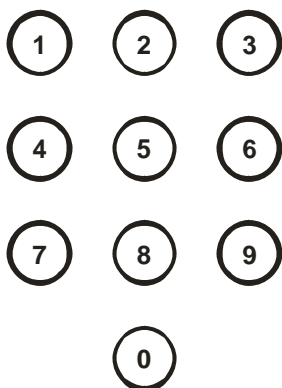

2.2 Quad Display

Select quad display on the main monitor by pressing the **QUAD** key. Cameras 1, 2, 3 and 4 will be displayed together.



On 9 camera models, if the **QUAD** key is pressed again, cameras 5, 6, 7 and 8 will be displayed. Successive presses will toggle between the two sets of images.

Press a number key to revert to full screen display of one camera.

2.3 9-way Multi-Screen

Select x9 Multi-Screen display on the main monitor by pressing the **MULTISCREEN** key (9-camera models only):



Press a number key to revert to full screen display of one camera.

2.4 Spot Monitor

To step forwards or backwards through the cameras displayed on the spot monitor, press one of these keys:



Intelligent Security & Fire

3 FIND

If there is a CD in the CD drive with previously stored images on it, the Vi200 will replay from the CD. Otherwise, the Vi200 will replay from the built-in hard drive.

3.1 FIND-1 Date/Time

This mode finds images by date and time. Press this key to enter the Date/Time search mode:



Sometimes it is useful to press the **DEF** key when in search mode, to call up the latest available recorded images

Use the **NUMBER** keys to enter any date and time for which there is still video available.

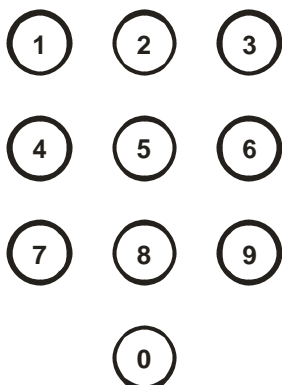

The format for the date and time is **DD/MM/YY HH:MM:SS** where:

- DD is the day of the month (00 to 31),
- MM is the month (01 to 12),
- YY is the year (e.g. 04 for the year 2004),
- HH is the hour in 24-hour format (00 to 23),
- MM is the number of minutes past the hour (00 to 59) and
- SS is the number of seconds past the minute (00 to 59).

Scroll through dates and times using the **ARROW** keys:

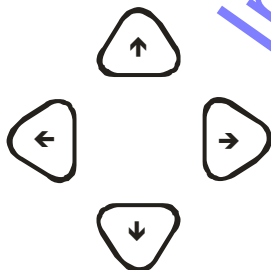

Note that as any digit of the date and time is changed, the corresponding image is immediately found on the hard drive and displayed.

This is the "active search" facility.

When you have found what you want, use the play keys to view the video:



3.2 FIND-2 Sweep

An alternative to the date/time search, is the sweep facility. Press this key until the sweep mode is displayed:



Use these keys to scan through the whole range of recorded images:



To step in finer time increments, press the **OK** key to access the fine mode.

Note that the slider changes from a solid block to a diamond.

Press again to cancel.

To quickly step between start, middle and end, press this key:



When you have found what you want, use the play keys to view the video:



3.3 FIND-3 Event List

When activity detection or alarm contacts are being used, events will be created in the event list. This screen allows you to quickly find an event and play the video associated with it.

Press the **FIND** key until the **FIND-3** screen is displayed:



System events and critical alerts also appear in the event list.

Entering the EVENT screen clears any critical alert conditions. If a critical alert problem still exists, new alert events will be created.

Use the up/down keys to scroll through events and the left/right keys to select different pages of events.

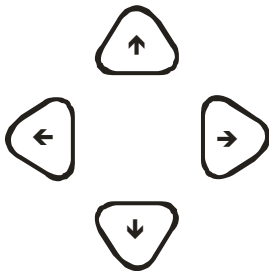

Up to 480 events can be recorded before older ones are over-written.

As events are highlighted, the corresponding image will be immediately recalled and displayed.

Press this key to go to the latest event:



When you have found what you want, use the play keys to view the video:



3.4 FIND-4 Incidents

If one or more incidents have been set (refer to BURN, section 5) they can be selected and replayed via this screen. This is particularly relevant when playing a CD.

Press the **FIND** key until the **FIND-4** screen is displayed:



When playing from a CD, all the stored video is within one or more incidents. This screen allows you to select which incident to play.

To select the incident you wish to replay, use these keys:



To play the incident forwards from the start, press the "play forward" key:



To play the incident backwards from the end, press the "play backwards" key:







4 PLAY

- If there is a CD in the CD drive with previously stored images on it, the Vi200 will replay from the CD. If the CD has more than one incident, use the FIND-4 screen to select each incident (see section 3.4).
- If there is no CD in the CD drive, the Vi200 will replay from the built-in hard drive.

Having found what you want using the **FIND** key, you can use these keys to move forwards and backwards through the recorded video images.



The function of each key is:

-  Step backwards one image
-  Step forwards one image
-  Play backwards (press again to increase speed)
-  Play forwards (press again to increase speed)
-  Pause at currently displayed image

Press the forward or reverse play keys repeatedly to increase the replay speed.



View different cameras by pressing the **NUMBER** keys:

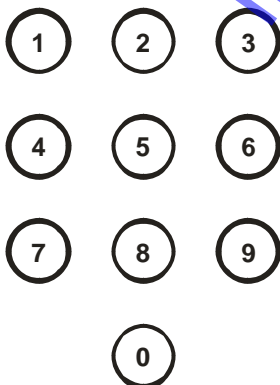

5 BURN

To burn a section of video recording to CD you must go to the middle the video that you wish to backup, using the FIND and PLAY facilities as described in sections 3 and 4. Then do the following:

5.1 BURN-1 Edit Incident

Call up the **BURN-1** screen by pressing this key.



If there is a CD in the CD drive that is *not* blank, the BURN screen will not be displayed.

Create an "incident" by pressing this key.



Change the duration of the incident as required using the left/right keys:



The start and end times can also be individually adjusted by using the **UP** and **DOWN** arrow keys to highlight the start or end times, and the **LEFT** and **RIGHT** keys to adjust the time.

Alternatively if you highlight the start time and press **DEF** it will be set to the current play image. Similarly if you highlight the end time and press **DEF** it will be set to the current play image.

Press the "Open CD drawer" button on the CD drive and place a *new* CD-R in the CD drive. Press the "Open CD drawer" button again to close the drawer.

Start writing to CD by pressing this key:



Note that you can only write incidents to a *blank* CD. **When an important incident has been written to a CD, always check that the CD plays back correctly**, either by playing it on the Vi200 or on a PC.

5.2 BURN-2 Multiple Incidents

Up to 4 incidents may be set before burning to CD. Use the **BURN-2** screen to manage multiple incidents and the **BURN-1** screen to edit individual incidents.

Use the **BURN** key to switch between the **BURN-1** and **BURN-2** screens:



While in the **BURN-2** screen, use these keys to highlight an incident:



Use these key to select whether you wish to include the highlighted incident when you burn to CD:



Use the **BURN** key to return to the **BURN-1** screen to set a new incident or to alter the length or times of an incident.



While in the **BURN-2** screen, start writing all selected incidents to **CD** by pressing this key:



Note that you can only write incidents to a *blank* CD. **When an important incident has been written to a CD, always check that the CD plays back correctly**, either by playing it on the VI100 or on a PC.

6 PSW (Passwords)

Passwords may be set in the menu to prevent unauthorised access to various features of the Vi200. Which features that are protected by each password may be defined in the menu (see section 9.6.1).

6.1 Log-On

To log-on to the Vi200 and thereby gain access to functions protected by the password:

Press this key:



Enter the correct password using the **NUMBER** keys:



Press this key:



A message on the screen will indicate whether user access has been granted. Four different passwords may be set up, each with different rights. Note that you may be granted access but still have insufficient rights to access some features of the Vi200 (see section 9.6.1 for details).

6.2 Log-Off

When you have finished accessing password protected features, you should log-off again to prevent other users gaining unauthorised access:

Press this key:



Press this key:



The password protected features are now protected again.

If no buttons are pressed on Vi200 for a period of 5 minutes the Vi200 will automatically time out of user profile.

Intelligent Security & Fire

7 FN (Functions)

The “FN” key provides additional functions as listed below.

7.1 Cancel All

Press these keys to cancel all functions to their defaults (i.e “No” states)



7.2 Panic Record - Yes

Press these keys to start recording at maximum rate irrespective of alarms and timers.



7.3 Panic Record - No

Press these keys to revert to recording at the normal rate.



7.4 Disable Alarms - Yes

Press these keys to disable the alarm inputs



7.5 Disable Alarms - No

Press these keys to enable the alarm inputs



7.6 Disable Activity - Yes

Press these keys to disable activity detection



7.7 Disable Activity - No

Press these keys to enable activity detection



7.8 Seq Main - Yes

Press these keys to *start* auto-sequencing of all cameras on the main monitor



7.9 Seq Main - No

Press these keys to *stop* auto-sequencing of all cameras on the main monitor



7.10 Seq Spot - Yes

Press these keys to *start* auto-sequencing of all cameras on the spot monitor



7.11 Seq Spot - No

Press these keys to *stop* auto-sequencing of all cameras on the spot monitor



8 INFO

A number of information screens are available to tell you about the Vi200 and to confirm that it is operating in the way that you intend:

Press this key to step through these various information screens:



8.1 INFO-1 Configuration

This screen displays the model, serial number and firmware revision.

8.2 INFO-2 Status

This screen displays the current system status, including date/time of images available on the hard drive

8.3 INFO-3 Drives

This screen shows the type and size of CD and hard drives fitted. The SMART disc monitoring status is also displayed. Drives can be re-scanned by pressing the **OK** key.

8.4 INFO-4 Record

Information related to the record process is displayed here, including image update rate and the expected number of days data retention.

8.5 INFO-5 Play

Information related to the currently displayed play images displayed here, including image date/time, number and authentication status.

To return to viewing live images, press this key:



9 MENU

To enter the menu, press this key:



Changes within the menu system require the use of the following keys:

The **ARROW** keys are used to move through the menus and to alter settings within the menu:

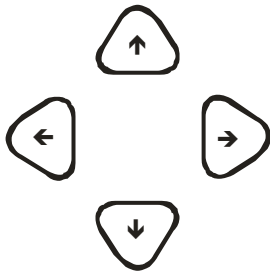

If you are uncertain about a menu setting, the default option can be selected using this key:



In parts of the menu you may need to initiate an action by pressing the **OK** key:



In parts of the menu you may need to enter numbers using the **NUMBER** keys:

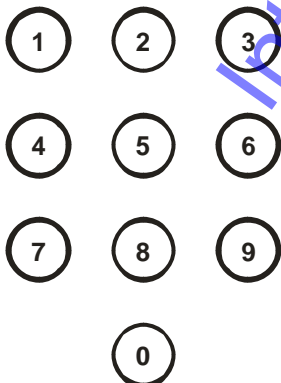

To exit the menu at any time, press this key:



9.1 Date/Time

For proper operation of the Vi200 Digital Recorder it is essential that the date and time are set correctly.

9.1.1 Date/Time

When you have found this menu item (see start of section 9), press this key to start editing the date and time:



Use the **NUMBER** keys to enter the date and time:

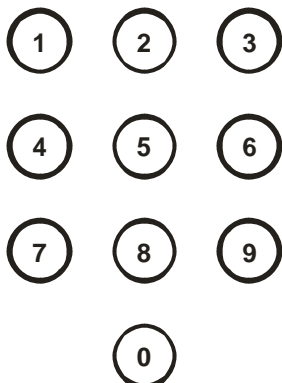

The format for the date and time is **DD/MM/YY HH:MM:SS** where:

- DD is the day of the month (00 to 31),
- MM is the month (01 to 12),
- YY is the year (e.g. 04 for the year 2004),
- HH is the hour in 24-hour format (00 to 23),
- MM is the number of minutes past the hour (00 to 59) and
- SS is the number of seconds past the minute (00 to 59).

The arrow keys may be used to move the cursor to different positions if only some digits need changing:



Press OK to finish:



9.1.2 Summer/Winter Time

If this menu item is set to **Automatic**, the displayed time and date will automatically change in spring and autumn. If you are in a country with different light saving hours, you can use this menu item to manually select summer-time (1 hour ahead) or winter-time. The date/time setting in section 9.1 should *not* be changed other than to adjust any drift in the timekeeping of the Vi200.

9.2 Record

9.2.1 Days

Enter here the number of days that you wish images to be retained for before being overwritten. The Vi200 will automatically calculate the number of images per second recorded to achieve this.

- More days results in fewer images per second
- Fewer days results in more images per second

The image rate may be viewed at any time using the **INFO-4** screen (see section 8).

Note that the actual number of days retained may vary from the programmed value, particularly if alarms are used. This is because alarms record at the maximum record rate and therefore use up hard disc space more rapidly. You may wish to increase the number of days to allow for this.

The following table shows examples of overall record rates (images per second) for different hard drive options and different numbers of days. An average image size of 18K is assumed (medium quality).

Hard Drive Capacity	7 days	14 days	31 days
80	7.35	3.67	1.66
160	12.5 (14.7)	7.35	3.3
250	12.5 (23)	11.5	5.2
400	12.5 (25)	12.5 (18.4)	8.3

The figures in brackets are the update rates when a single camera is being recorded, using camera 1 input.

To get the image rate per camera, divide by the number of cameras being recorded.

9.2.2 Cameras

Select here which cameras you wish to record when there is no activity or alarm in progress. Typically, all cameras would be selected.

9.2.3 Quality

Select the image quality here. Note that the quality (i.e. image size) affects the record rate for a given number of days recording. Image quality may be adjusted to suit the particular installation. Note that:

- Higher quality images result in fewer images per second
- Lower quality images result in more images per second

The actual size of the stored image in (Kbytes) depends on the content of the image. Scenes with a lot of information result in larger images. Scenes with little information (e.g. empty rooms), result in smaller images. The use of variable image size maximises the use of the available hard drive capacity.

9.2.3.1 Audio Sensitivity

This option sets the sensitivity of the record input. It should be set as high as possible before the onset of clipping (distortion) of the audio is apparent.

- If the audio is distorting even at minimum sensitivity, then the signal level being fed in is too high and should be reduced.
 - If the audio is weak and noisy, the input level may be too low and should be increased. If the microphone input shows these symptoms, and external microphone pre-amplifier may be needed.
-

9.2.4 Timers

Large hard drives and continuous recording is generally recommended where possible to achieve maximum security and to maximise evidence in the case of crime.

However, timers are provided to restrict when recording occurs should this be required. This saves hard drive space and allows faster updates to be used in the periods when recording is taking place.

9.2.4.1 Weekday

Specify the times recording occurs for Monday, Tuesday, Wednesday, Thursday and Friday using the **LEFT**, **RIGHT**, **UP** and **DOWN** keys.

9.2.4.2 Weekend

Specify the times recording occurs for Saturday and Sunday using the **LEFT**, **RIGHT**, **UP** and **DOWN** keys.

Intelligent Security & Fire

9.3 Display

9.3.1 Keypad Brightness

The brightness of the backlit keypad may be adjusted here using the **UP** and **DOWN** keys.

9.3.2 Auto Seq Dwell - Main

When auto-sequencing cameras on the main monitor (see section 7.8), the dwell time is specified by this option using the **NUMBER** keys.

9.3.3 Auto Seq Dwell - Spot

When auto-sequencing cameras on the spot monitor (see section 7.10), the dwell time is specified by this option using the **NUMBER** keys.

9.3.4 Camera Titles

Each camera may be given a title, or the default title may be used ("Camera1", "Camera2" etc).

You can use the **NUMBER** keys for numbers and the **UP** and **DOWN** arrow keys to get letters and other characters. Press the **BACK** or **LEFT** key to go back to the previous menu level. Or use the + and - keys to scroll through the units preset camera titles.

Intelligent Security & Fire

9.4 Alarms

9.4.1 Activity Detection

Activity detection zones may be set for each camera.

Use the **UP** and **DOWN** keys to highlight different rows.

If you select the top (text) row, the sensitivity and pixel count can be set.

The sensitivity affects all selected pixels (zones). The higher this setting, the more sensitive the activity detection is.

- Use the **NUMBER** keys 1-4 to set sensitivity (Sen)

The pixel count specifies the number of zones that have to be simultaneously active in order to trigger an activity alarm (i.e. the higher the pixel count, the lower the chance of triggering)

- Use the **NUMBER** keys 5-9 to set the number of pixels (Pix)

As you select the various rows over the image, the **NUMBER** keys turn the zones across the line on and off. If a zone is turned on, it will be sensitive to changes in the image.

The **DEF** key may be used to toggle all zones one or off.

9.4.2 Relay Hold Time

Following an activity or alarm contact event, the relay is operated and held for a programmable number of seconds.

9.4.3 Video Loss Alert

Set the cameras here that you wish to monitor for video loss (i.e. camera failure). The simplest method is to press the **DEF** key. This will automatically check all the currently connected cameras.

9.4.4 Clear Event List

The event list is cleared using this option. Press **OK** to clear all events.

9.4.5 Alarm Timers

9.4.5.1 Weekday

Specify the times when alarm inputs are to be enabled for Monday, Tuesday, Wednesday, Thursday and Friday using the **LEFT**, **RIGHT**, **UP** and **DOWN** keys.

9.4.5.2 Weekend

Specify the times when alarm inputs are to be enabled for Saturday and Sunday using the **LEFT**, **RIGHT**, **UP** and **DOWN** keys.

9.4.6 Activity Timers

9.4.6.1 Weekday

Specify the times when activity detection is to be enabled for Monday, Tuesday, Wednesday, Thursday and Friday the **LEFT**, **RIGHT**, **UP** and **DOWN** keys.

9.4.6.2 Weekend

Specify the times when activity detection is to be enabled for Saturday and Sunday using the **LEFT**, **RIGHT**, **UP** and **DOWN** keys.

Intelligent Security & Fire

9.5 Network

Remote access software for the PC is available on the internet: www.videoswitch.co.uk

9.5.1 IP Address

If the Ethernet port of Vi200 is being used, a suitable IP address must be set. The IP address must be unique and compatible with other devices on the network to which it connects. If it is the only device connected to a router, the default IP address should be suitable. Otherwise, refer to the network administrator. If you are connecting to a PC and there is not a DHCP server, the PC will need to be programmed with a fixed IP address.

See section 11 for details of how to connect your Vi200 using the Ethernet connector.

9.5.2 Port

The default port setting (9221) should be suitable in most cases. Otherwise, refer to the network administrator

9.5.3 Sub-Net mask

The default sub-net mask should be suitable in most cases. Otherwise, refer to the network administrator

9.5.4 Gateway

The default gateway should be suitable in most cases. Otherwise, refer to the network administrator

9.5.5 PSTN Rings

If a PSTN adaptor is being used, the number of rings before it answers may be set here.

9.5.6 Dial-up Type

Specify here whether an ISDN, PSTN or no remote dial-up adaptor is connected

9.6 Configuration

9.6.1 Passwords

There are four passwords that may be used to provide different access rights to up to four different categories of user:

- User1
- User2
- User3
- User4

Associated with each password access rights that may be individually permitted or denied:

- Keypad
- Play
- Date/Time Menu
- Display Menu
- Record Menu
- Alarms Menu
- Network Menu
- Config Menu
- Upgrades
- Remote Access
- Coverts
- Burn
- Events
- Function

Intelligent Security & Fire

9.6.1.1 Logged-Off Access Rights

If no password has been entered the "Logged-Off" access rights apply.

9.6.1.2 User 1

9.6.1.2.1 User 1 Password

If you wish to change the password for USER1, enter a six digit number here. The default password is "111111".

If you change this password, be very careful to make sure that it is remembered, otherwise access to the menus may not be possible again.

9.6.1.2.2 User 1 Access Rights

The features that this password allows access to are set here using the UP, DOWN, LEFT and RIGHT arrow keys. A solid block means that the password gains access to a feature, a dash indicates that access is denied to that feature.

Note that User 1 always has access to the **Keypad** and **Config menu**.

9.6.1.3 User 2

9.6.1.3.1 User 2 Password

If you wish to change the password for USER2, enter a six digit number here. The default password is "222222".

9.6.1.3.2 User 2 Access Rights

The features that this password allows access to are set here using the UP, DOWN, LEFT and RIGHT arrow keys. A solid block means that the password gains access to a feature, a dash indicates that access is denied to that feature.

9.6.1.4 User 3

9.6.1.4.1 User 3 Password

If you wish to change the password for USER3, enter a six digit number here. The default password is "333333".

9.6.1.4.2 User 3 Access Rights

The features that this password allows access to are set here using the UP, DOWN, LEFT and RIGHT arrow keys. A solid block means that the password gains access to a feature, a dash indicates that access is denied to that feature.

9.6.1.5 User 4

9.6.1.5.1 User 4 Password

If you wish to change the password for USER4, enter a six digit number here. The default password is "444444".

9.6.1.5.2 User 4 Access Rights

The features that this password allows access to are set here using the UP, DOWN, LEFT and RIGHT arrow keys. A solid block means that the password gains access to a feature, a dash indicates that access is denied to that feature.

9.6.2 Covert Cameras

One or more cameras may be set as covert (hidden). This means that, unless a user logs on with covert access rights, those cameras will *not* be visible in live or replay.

When setting covert cameras, remember to also do the following:

- Remove covert rights from the “Logged Off Access Rights”
- Remove covert rights from all of the users who should not have access
- Remove Config Menu rights from all of the users who should not have access
- Remove BURN rights from all of the users who should not burn CDs (which have the covert cameras on)
- Remove EVENT rights from all of the users who should not see the event list (which may have activity and alarms relating to covert cameras)

Having correctly set up the Access Rights (see section 9.6.1), if you now want to view covert cameras, enter a password that *does* have covert access rights. Remember to log off (enter no password) when you have finished viewing. Do not use Camera 1 as a covert camera.

9.6.3 Camera Inputs

9.6.3.1 Record Brightness

The brightness of the images being recorded can be adjusted to compensate for cable losses. Adjust the brightness as required for each camera.

- If the displayed image (which is digitised) is too dim or is tearing, *increase* the brightness setting.
- If an image is too bright, *decrease* the brightness setting.

9.6.3.2 Record Colour Boost

The colour content of the images being recorded can be adjusted here to compensate for cable losses. Adjust so that the colour content of the displayed image is not too weak or too strong.

9.6.4 Record Audio

A single channel of audio recording and playback is available, optimised for speech. Two audio inputs are provided. Only one of these should be used at a time:

- Microphone This is suitable for an electret microphone
- Line This is suitable for the output from a microphone pre-amplifier

The audio output is suitable for feeding to a power amplifier (with volume control) and speaker. Multi-media PC speakers with built-in amplifiers are ideal.

Refer to section 10 for details of connecting the audio inputs and output.

If you wish to use the audio record/play facility set this option to YES. Otherwise set to NO.

Audio recording uses a about 350Mbytes of hard disc per day which amounts to about 11 Gbytes per month. If you do not need audio, the space saved will be used for video recording. Once set on or off, this option should not be changed during normal use as this may affect recall of previously recorded video images.

9.6.5 Restore Factory Config

Press the **YES** key to restore the configuration to the factory defaults.

9.6.6 Erase Hard Drive

Press the **YES** key to erase the hard drive.

9.6.7 Remote Keyboard Monitor

If you are using a remote keyboard, select here whether you wish to view and control the main monitor or the spot monitor. The main monitor provides access to the menus and multi-screens. The spot monitor provides independent full screen views of any camera.

Intelligent Security & Fire



Digital Recorder

9.6.8 Unit Address

This address need only be changed if more than one Vi200 is to be controlled from one remote keyboard.

In this case, give each Vi200 a different unit address. For example "001", "002", "003" etc.

Intelligent Security & Fire

10 Audio

- Connect a microphone either directly to the MIC input or via a microphone amplifier to the LINE input.
- The LINE output is used to drive either a speaker with a built-in amplifier or a separate amplifier and speaker.

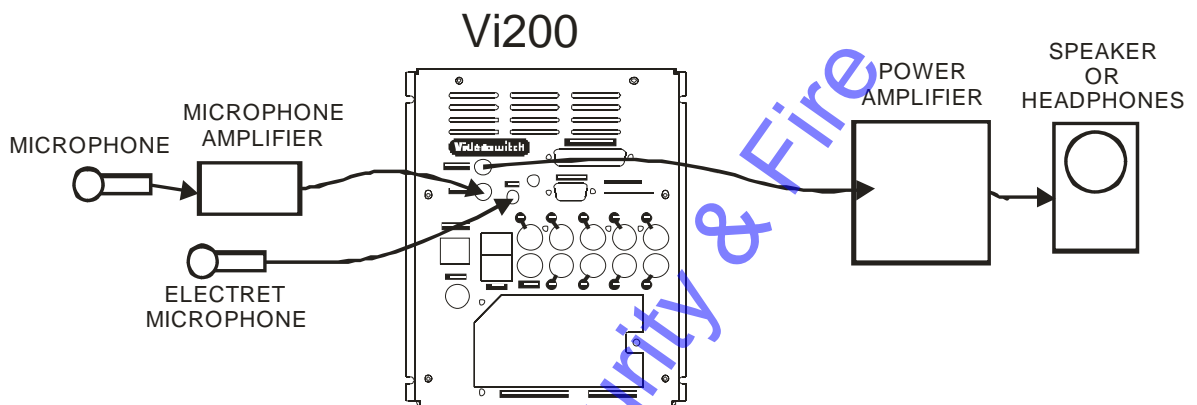

11 Ethernet

11.1 Ethernet connection to a PC

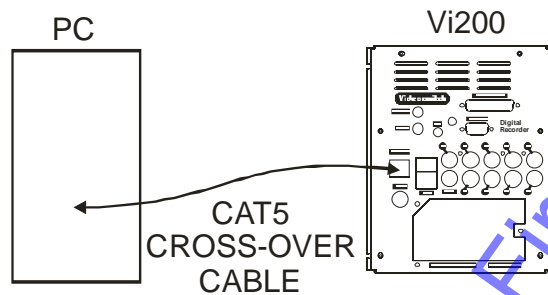

11.2 Ethernet connection to a LAN network

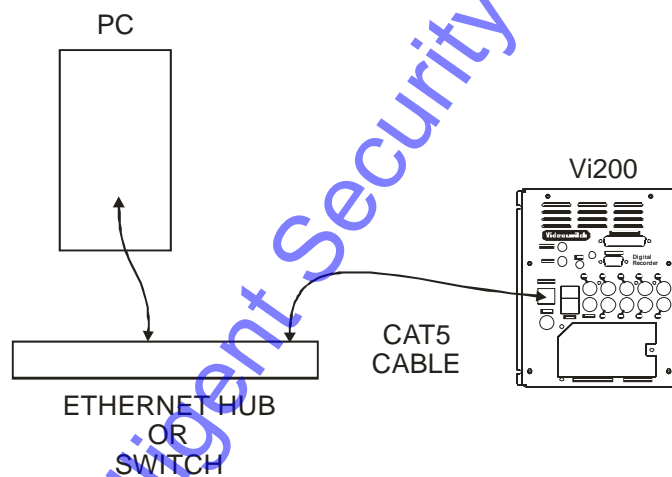

11.3 Ethernet connection to an ADSL router

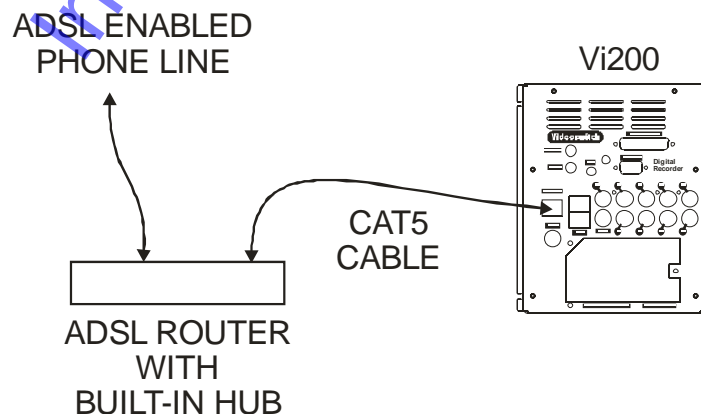

12 Remote Keyboard

A remote keyboard may be connected to the Vi200 to provide control from another room. Simply connect the Vi200 to the keyboard using Cat 5 (or similar twin twisted pair cable).

Connect the keyboard to a monitor using a BNC co-ax cable. All the keys of the Vi200 are duplicated on the remote keyboard and the Vi200 may be controlled in the same way.

If the keyboard is more than about 100 metres away from the Vi200, then the monitor should be connected to the Vi200 separately via a BNC cable (RG59) to ensure best picture quality. The CAT5 data connection should operate up to 500 metres.

The keyboard and monitor may control and view either the main monitor or the spot monitor according a menu setting (see section 9.6.7).

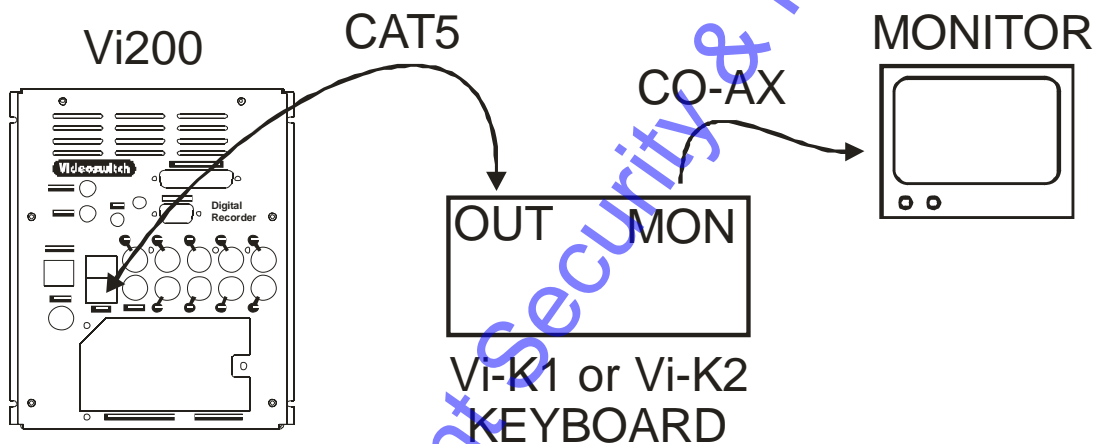

The remote keyboard can control and display either the **MAIN** monitor or the **SPOT** monitor. See section 9.6.7 to select one of these modes of operation.

13 Dial-Up Access

Images may be viewed on a PC via a telephone line (PSTN or ISDN) if an optional external Vi-PSTN or Vi-ISDN adaptor is attached.

Software for the PC is available on the internet: www.videoswitch.co.uk

13.1 Vi-PSTN

This external adaptor is for use with a standard telephone line. The adaptor plugs into the PSTN/ISDN connector on the Vi200. A PC with a modem is required to view the images.

13.2 Vi-ISDN and Vi-ISDN/TA

This external adaptor is for use with an ISDN telephone line. The adaptor plugs into the PSTN/ISDN connector on the Vi200. A PC with a Vi-ISDN/TA is required to view the images.

13.3 Connecting a Dial-up Adaptor

- Connect the Vi-ISDN or Vi-PSTN adaptor to the Vi200 using the 9-way D-type cable provided with the adaptor. No power supply is required.
- Connect the adaptor to the ISDN or PSTN telephone socket using the cable provided with the Vi-ISDN or Vi-PSTN adaptor.
- Install Vi-Connect or VDM-Connect software in the PC that is to be used to dial into the Vi200. A modem must be fitted for PSTN use, or a Vi-ISDN/TA terminal adaptor for ISDN use.

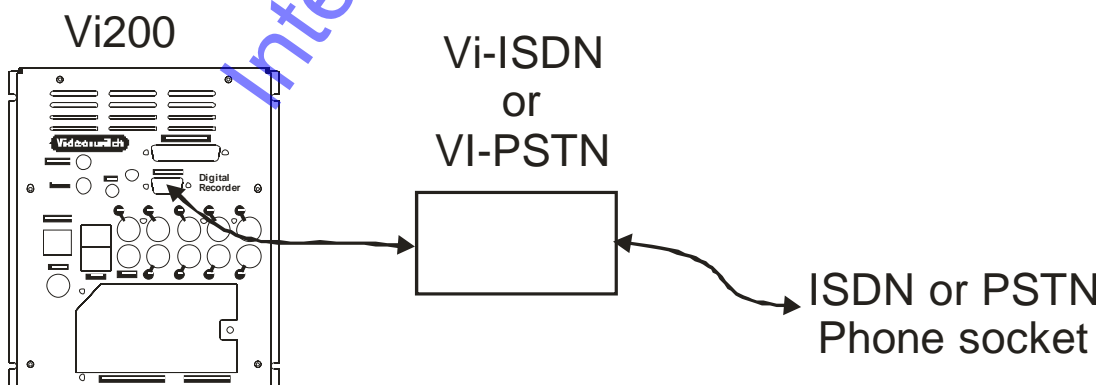

14 Technical Data

14.1 Power-On Reset

If you wish to perform a power-on-reset to restore all settings to their factory defaults, press the **DEF** key while you apply power, and keep pressing it until the Vi200 has powered up and displays **FACTORY RESET**. Note that this process will reset all user settings, including camera titles. The **DEF** key will need to be pressed for about 10 seconds.

The factory configuration can also be recalled via the menu (see section 9.6.4).

14.2 Accessories Included

Vi200
Mains Cable
Vi-X1 Alarm Break-out module
Hard Drive Key
Manual
CAT5 Ethernet Cable
Blank CDs (2)

14.3 Changing the Hard Drive

Hard drives are sensitive mechanical devices that may be damaged by shock or vibration. Always protect them from shock and vibration when transporting.

Remove power from the Vi200 before removing the hard drive. **Wait for 30 seconds for the drive to stop spinning** before moving the Vi200 or removing the hard drive. Moving a drive that is still spinning can damage it.

The hard drive drawers require a special key to unlock them. This is supplied with the Vi200. Insert the key, and turn it *clockwise* to unlock the drive.

To put a hard drive back into the Vi200, make sure that the lock in the drive drawer is in the *unlocked* position. Carefully slide the drawer in as far as it can go with the handle in the up position. Carefully push the handle down such that the drawer is pulled into the drive bay. When it is properly located, lock the drawer by turning the key *counter-clockwise*.

After changing a drive, re-apply power to the Vi200.

14.4 Connector Pin-Outs

14.4.1 Alarms

Physical: 25-way D-Type (female)

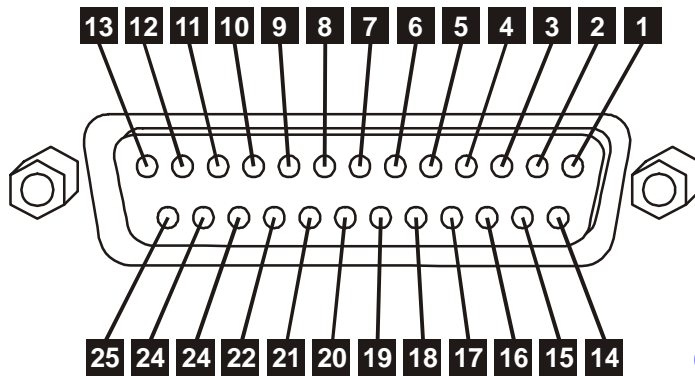

Pin Number	Signal	In/Out
1	Alarm Common (Ground)	In
5	Alarm 9	In
8	Alarm 1	In
9	Alarm 3	In
10	Alarm 5	In
11	Alarm 7	In
12	Relay N/C	Out
13	Relay N/O	Out
21	Alarm 3	In
22	Alarm 4	In
23	Alarm 6	In
24	Alarm 8	In
25	Relay Common	Out

Note:

The Vi-X1 break-out adaptor supplied with the Vi200 provides a convenient means of making connection to the alarm inputs and relay outputs via screw terminals.

14.4.2 Remote Keyboard

Physical: RJ45 (lower connector)

Electrical: RS485

Pin Number	Signal	In/Out
1	RS485+ (A)	In
2	RS485- (B)	In
3	Not used	N/a
4	+12V for Keyboard	Out
5	0V for keyboard	Out
6	Not used	N/a
7	Twisted-Pair Video+	Out
8	Twisted-Pair Video-	Out

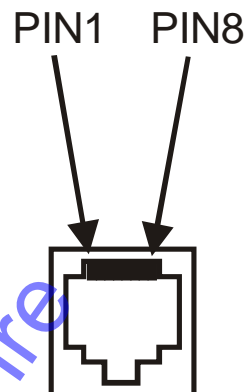

Note:

A standard CAT5 patch cable may be used to connect the Vi200 to the optional Vi-K1 keyboard.

14.4.3 PSTN/ISDN Modem

Physical: 9-way D-type (female)

Electrical: RS232

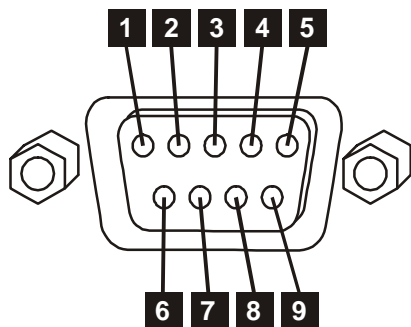

Pin Number	Signal	In/Out
1	DCD	In
2	RXD	In
3	TXD	Out
4	DTR	Out
5	GND	In/Out
6	+8V	Out
7	RTS	Out
8	CTS	In
9	RI	In

Intelligent Security & Fire

14.5 Specifications

14.5.1 Storage

Hard drive	80, 160, 250 or 400 Gbytes, removable.
CD writer	Quick and easy backup to CD-R using "BURN" key

14.5.2 Digital recording/Replay

Camera inputs	4 or 9
Image Retention	1 to 99 days, image rate calculated automatically
Colour/Monochrome	Auto sense
Gain, Brightness, Colour	Adjustable via menu
Resolution	720 x 576 pixels x 16.8 million colours
Image size	6k to 35k bytes, dynamically variable
Compression method	Wavelet
Hardware/Software	Embedded RISC processor, proprietary Videoswitch operating system (non PC)
Image retention period	31days default, 1-99 days programmable
Timer	Weekday and weekend record timer
Simultaneous record/play	Yes
Image authentication	Every image is tagged with time, date, image number and other information and is protected with a digital security signature for authentication.
Video input specification	0.5 to 1V pk-pk, 75 Ohms, composite PAL (BNC)
Single camera recording	25 images/second (use camera 1 input)
Multiple camera recording	12.5 images per second (this gives, for example, 20 days retention with image size of 18Kbytes and 400 Gbyte hard drive)

14.5.3 Display

Monitor outputs	Main and spot, 1V pk-pk composite PAL (BNC)
Display modes	Full screen, quad, 9-way split
Auto Sequencing	1-99 seconds
Covert (hidden)	Any cameras may be hidden from view on the monitors

14.5.4 Control and Interface

Keypad	35 illuminated single function keys, adjustable brightness
Passwords	Up to 4 passwords with programmable rights
Search modes	Date/time search, sweep, event list, incidents
Audio	Single channel audio recording/playback

Microphone	3.5mm jack, -56dB, 20k Ohms, suits electret microphone
Line input/output	2 Phono connectors, -30dB level, 47kOhms
Audio sensitivity control	30db range, via menu
Audio bandwidth	3.2kHz (optimised for speech)
Alarm inputs	9 inputs, suits normally open volt-free contacts
Activity detection	8 x 8 zones, programmable sensitivity
Alarm relay	25Vdc, 200mA max normally open or closed
Alarm/activity response	Pull-up full screen display, maximum record rate
Event log	480 alarm, activity and system events
Incident list	Up to 4 incidents may be saved onto one CD
Keyboard data input	RJ45, RS485, 9600 baud (1 start, 8 data, 1 stop)
Keyboard video output	Twisted-pair video via built-in balun for connection to remote keyboard. Main or spot monitor.
Watchdog timer	In the event of any unexpected condition, the system will automatically restart

14.5.5 Remote Viewing

PSTN/ISDN (option)	Adaptors are available for dial-up remote access
Ethernet	100baseT, TCP/IP, suitable for connection to broadband router or LAN. Software supplied.

14.5.6 Power, Physical & Environmental

Mains Power input	90-135 Vac 2 Amps or 180-265 Vac 1 Amp, 47-63Hz
Temperature	5 to 35deg C (operating), -10 to 40deg C (storage)
Humidity	5 to 95% non-condensing
Dimensions/Weight (Unit)	165mm x 200mm x 310mm (WxHxD), 6kg
Dimensions/Weight (Boxed)	275mm x 380mm x 475mm (WxHxD), 8kg

14.5.7 Upgrades

Remote viewing Software	Remote viewing software (VDM Connect or Vi Connect) is available on the internet: www.videoswitch.co.uk
Firmware upgrades	Future firmware upgrades will be made available on CD and the Internet (free of charge)
Cameras Input Upgrades	The number of camera inputs may be increased from 4 to 9 via an upgrade CD (chargeable)
Hard Drive Upgrades	The capacity of hard drive that is recognised may be increased via an upgrade CD (chargeable). Replacement hard drives also available.



Digital Recorder

14.5.8 CE Marking

This product is CE marked. It has been fully tested and complies with 89/336/EEC Electromagnetic Compatibility and 73/23/EEC Low Voltage directives, and with EN 60950:2000 safety standards.

Warning: This is a Class A product. In a domestic environment this product may cause radio interference in which case the user may be required to take adequate measures.

14.5.9 Ventilation

The Vi200 Digital Recorder has ventilation holes in the base, front and rear. Using internal fans, the unit creates a continuous flow of air through the unit to control the temperature of the disc drives and other internal components.

The ventilation holes must not be obstructed otherwise the lifetime and reliability of the system may be affected.

14.5.10 Safety

For warranty and safety reasons, the cover of this equipment must not be removed. There are no user serviceable parts inside.

Intelligent Security & EIP



Digital Recorder

Serial Number of Vi200

Notes

Intelligent Security & Fire



Digital Recorder

Intelligent Security & Fire



Digital Recorder

15 Warranty Fax-Back

Please fill-in and fax or post this form (or a copy) back to Videoswitch. This will enable us you to inform you of free upgrades when they become available. If this form is filled in fully and returned within 1 month of purchase the warranty on this product will be extended from 1 year to 2 years for no extra charge.

Serial Number of Vi200
(this is on the label under Vi200)

Your Name

Company Name

Address & Email

Date Purchased

Purchased From

Fax to:

01252-851296

or Send to:

**Videoswitch, Ocean House, Redfields Industrial Park, Redfields Lane
Church Crookham, Fleet, Hants GU52 0RD**

Intelligent Security & Fire

Intelligent Security & Fire