

# Operating Instructions

Video Switcher  
**WJ-SW208**

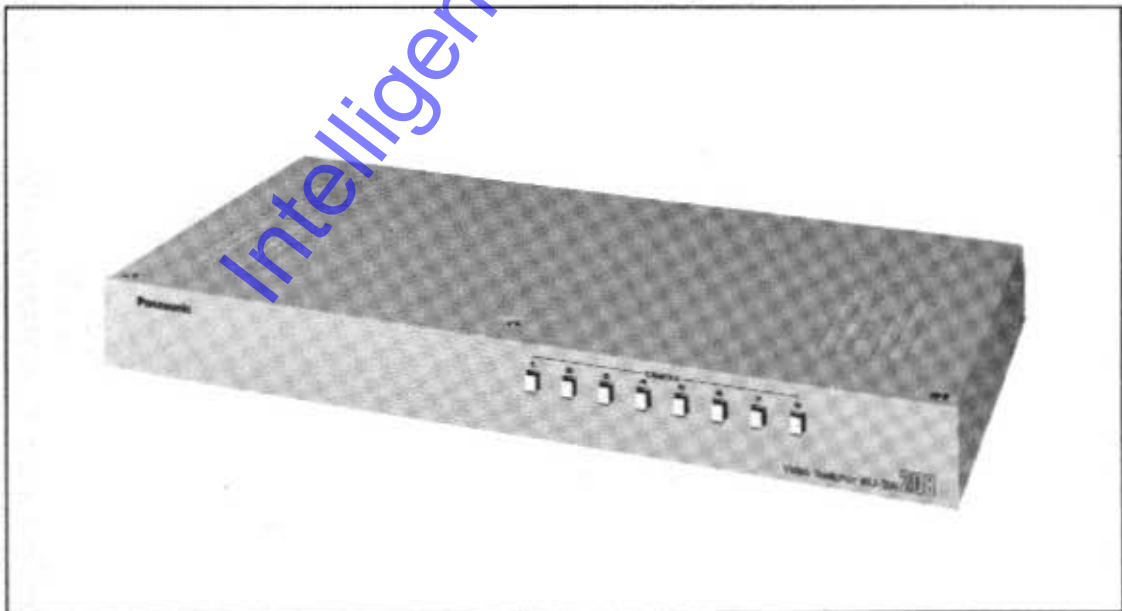

**Panasonic®**

Before attempting to connect or operate this product, please read these instructions completely.

# CONTENTS

PREFACE .....	2
FEATURE .....	2
PRECAUTIONS .....	2
MAJOR OPERATING CONTROLS AND THEIR FUNCTIONS .....	2
BLOCK DIAGRAM .....	3
SYSTEM CONNECTION .....	3
RACK MOUNTING .....	5
SPECIFICATIONS .....	5
STANDARD ACCESSORIES .....	5

Intelligent Security & Fire

The serial number of this product may be found on the bottom of the unit. You should note the serial number of this unit in the space provided and retain this book as a permanent record of your purchase to aid identification in the event of theft.

Model No. \_\_\_\_\_

Serial No. \_\_\_\_\_

## PREFACE

The Panasonic Video Switcher WJ-SW208 is used for switching the camera input signal of up to 8.

## FEATURES

- Loop-through output with the automatic termination are provided.
- By the combination of the System Controller WV-CU101, up to 8 Combination Camera WV-CS304, Pan/Tilt Head or Receiver can be used.
- Mountable on a EIA standard 19-inch rack

## PRECAUTIONS

- Do not expose this unit to water or moisture.
- Do not operate this unit if it becomes wet. Do take immediate action if ever this unit does become wet. Refer servicing to qualified service personnel. Moisture can damage this unit.
- Do attempt to disassemble this unit. Do not remove screws or cover. There are no user-serviceable parts inside. Refer servicing to qualified service personnel.
- Use this unit under conditions where temperature are within  $-10^{\circ}\text{C}$  -  $+50^{\circ}\text{C}$  and humidity is below 90%.
- Do not use strong or abrasive detergents when cleaning the unit body.
- Every necessary procedures with regard to install this unit should be made by qualified service personnel or system installer.

## MAJOR OPERATING CONTROLS AND CONNECTORS

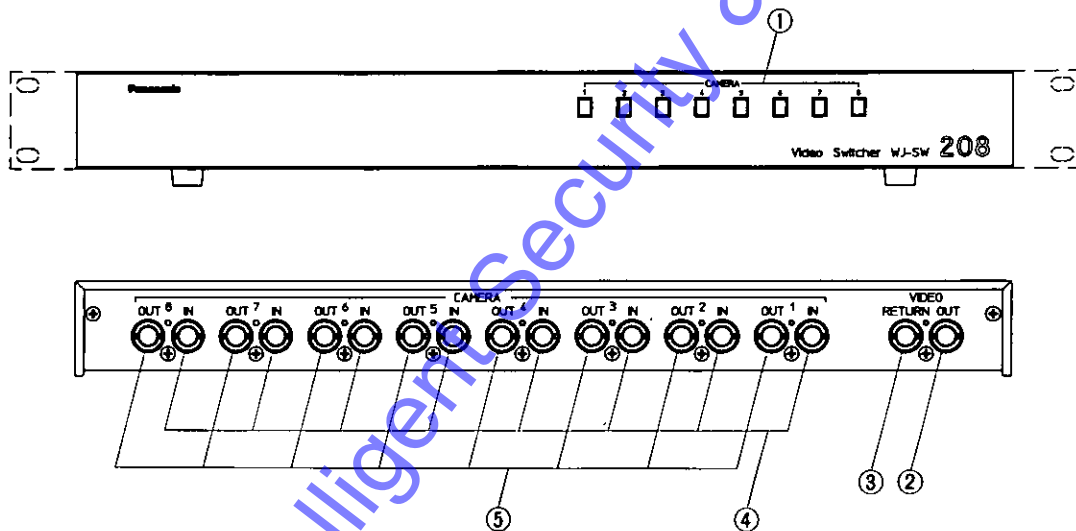

### 1. Camera Selection Switch

(CAMERA, 1/2/3/4/5/6/7/8)

These switches are used to choose the camera signal.

Notes :

- When the camera signal is switched by this switcher, switching noise will be occurred.
- Be sure to press only one switch at one time.

### 2. Video Output Connector (VIDEO OUT)

This is a BNC type connector.

The video signal selected by the Camera Selection Switch is output from this connector.

Note :

The ground of the video signal is isolated from the chassis.

### 3. Video Return Connector (VIDEO RETURN)

This is a BNC type connector.

The loop-through video signal of the Video Output Connector will be returned to this connector.

Note :

The ground of the video signal is isolated from the chassis.

### 4. Camera Input Connector (CAMERA IN)

The camera signal should be supplied to this connector.

Note :

The ground of the video signal is isolated from the chassis.

### 5. Camera Output Connector (CAMERA OUT)

The camera signal is output from this connector.

When the cable is not connected to this connector, this connector is terminated with 75 ohms automatically.

Note :

The ground of the video signal is isolated from the chassis.

# BLOCK DIAGRAM

The loop-through output of the selected channel is not available unless the video return signal can not be obtained.

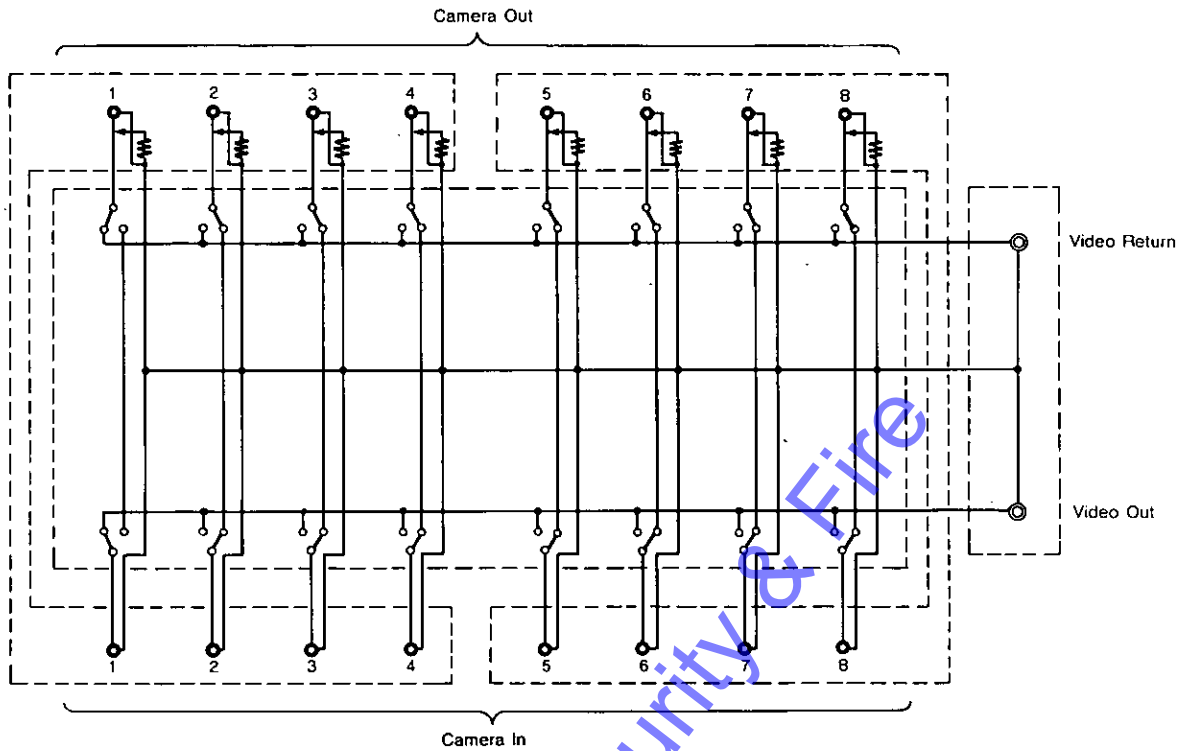

# SYSTEM CONNECTION

1. Connect the coaxial cables between the video output of the cameras and the Camera Input of this unit.
2. Connect the coaxial cable between the Video Output Connector of this unit and the camera input connector of the Remote Control Unit WV-CU101.
3. Connect the coaxial cables between the video output of the Remote Control Unit WV-CU101 and the video input connector of the monitor.
4. Connect the coaxial cables between the Video Return Connector of this unit and the video output of the monitor.
5. Connect the coaxial cables between the Camera Output Connectors of this unit and the video input of the Quad Unit WJ-450.

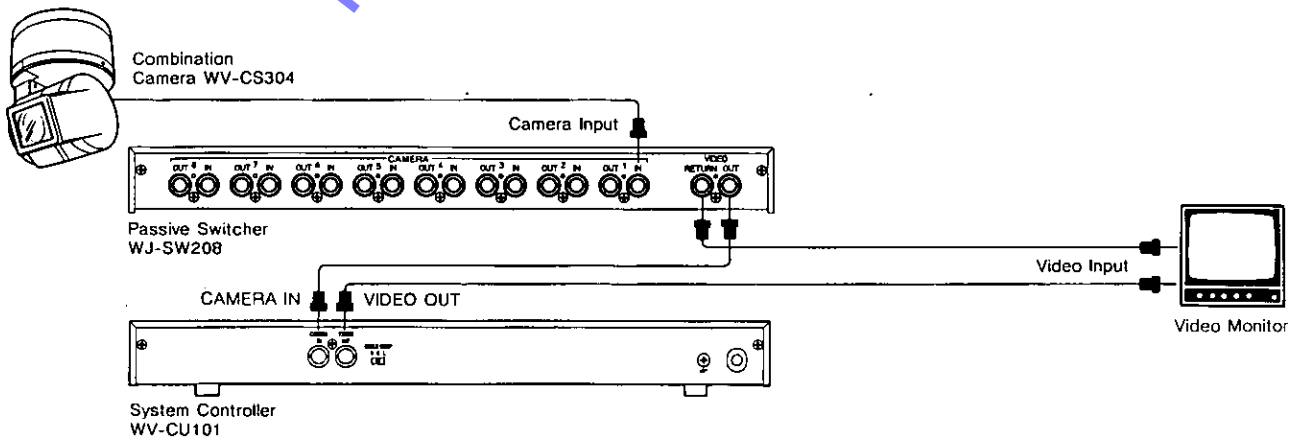

## Loop-through Output Description

The loop-through output of this unit is shown in the following.

(Example 1)

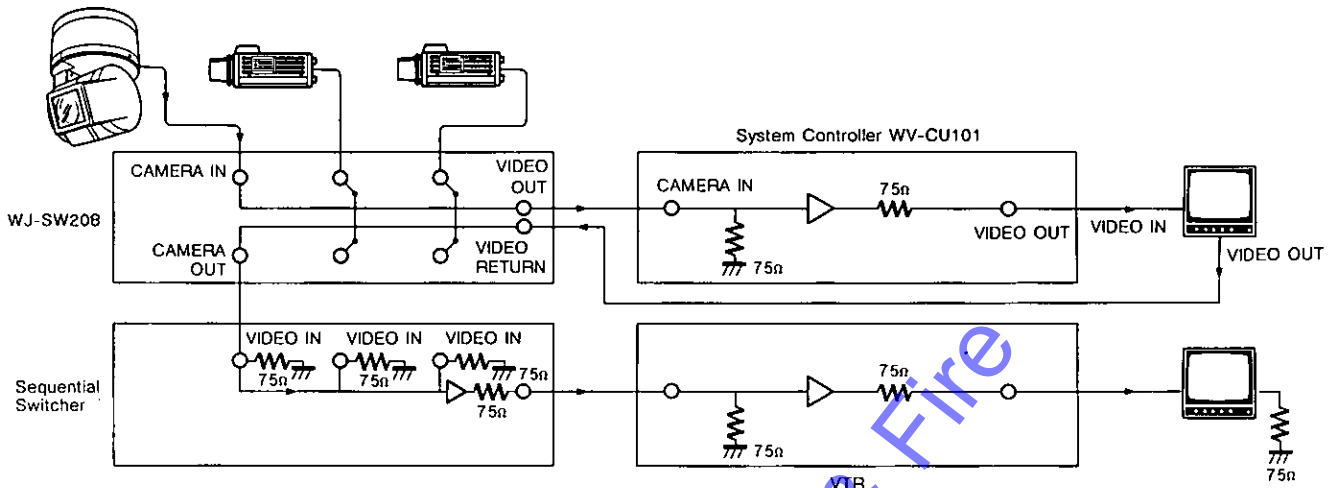

(Example 2)

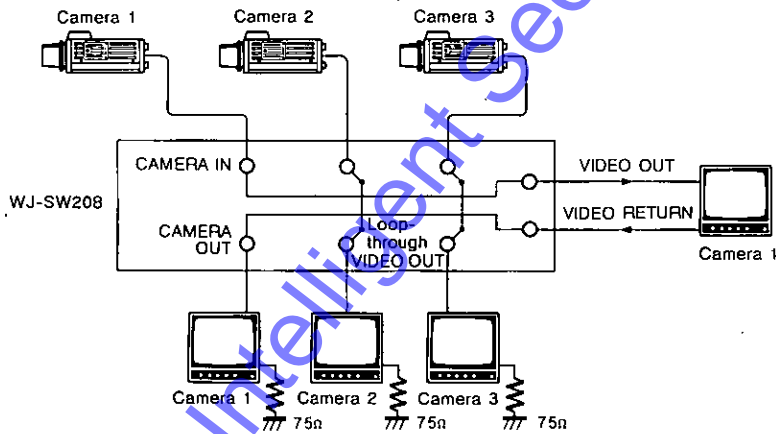

Note :

The loop-through output of the selected channel is not available unless the video return signal can not be obtained.

## RACK MOUNTING

This unit is designed to be mounted on a EIA standard 19-inch rack, use Rack Mount Angles (provided) and four Mounting Screws (M4) (provided).

1. Remove four Mounting Screws fixing the rubber legs and remove four rubber legs from the bottom of the unit.
2. Attach the Rack Mount Angles on both sides and fix them by using four screws provided with the Rack Mount Angle.
3. Install the Video Switcher WJ-SW208 on the EIA 19-inch rack by using four screws (locally procured).

### Cautions :

1. Keep 1-unit or more space at the top and bottom of the unit.
2. Secure the rear of the unit to the rack by using the additional mounting angles (locally procured) to prevent damage to the unit from vibration.

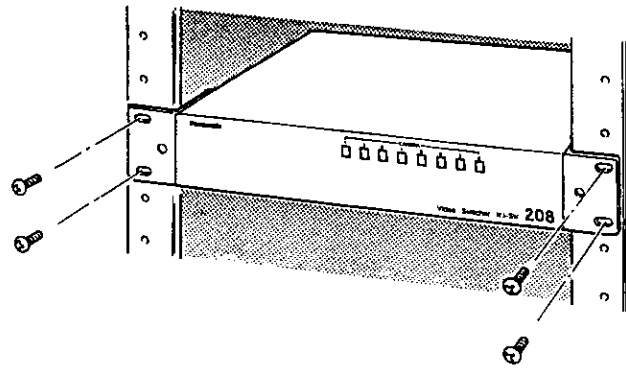

## SPECIFICATIONS

Camera Input :	8 Inputs, BNC Connector
Camera Loop-through Output :	8 Outputs, BNC Connector
Video Output :	1 Output, BNC Connector
Video Return Input :	1 Input, BNC Connector
Camera Selection Switch :	Mechanical lock-release type
Ambient Operating Temperature :	-10°C - +50°C
Dimensions :	16-9/16" (W) × 1-3/4" (H) × 8-7/8" (D) (420 (W) × 44 (H) × 225 (D) mm)
Weights :	5.1 lbs. (2.3 kg)

Dimensions and weight shown above are approximate.  
Specifications are subject to change without notice.

## STANDARD ACCESSORIES

Rack Mount Angle .....	1 set
Mounting Screw .....	4 pcs.

Intelligent Security & Fire

# Panasonic

Broadcast & Television Systems Company

Division of Matsushita Electric Corporation of America

**CLOSED CIRCUIT VIDEO EQUIPMENT DIVISION**

Executive Office: One Panasonic Way 3E-7, Secaucus, New Jersey 07094

Intelligent Security & Fire